

Petrel120

FPV Racing Drone

Manual





Contents

Product Specifications.....	1
Interface Description.....	2
Check the flight control drive.....	3
Calibration accelerometer.....	4
URAT serial port use.....	5
Select aircraft model.....	6
Choose ESC protocol.....	7
Select ESC telemetry.....	8
Voltage parameters setting.....	9
Setting up the receiver.....	10
VTX serial port use. VTX uses OSD smart audio.....	11
Check receiver signal.....	13
Select flight mode startup mode.....	14
OSD settings.....	15
LED settings.....	16
Troubleshooting.....	17

.....

Package Included

Petrel120 FPV Racing Drone*1	
------------------------------	--

1. Product Specifications

Product parameters	
Model	Petrel120 FPV Racing Drone
Weight	BNF: 57.6g PNP: 54.9g
Frame Kit	Petrel120 Frame Kit
Flight Controller	FD411
ESC	FD 13A 4in1
VTX	FD VTX Micro
Camera	Turbo Eos v2
Motor	FD1103 kv8000
Support receiver	SBUS .PPM..DSMX.i.BUS
Input Voltage	3S Lipo
Size	98X88mm (body dimension)

2. Interface Description

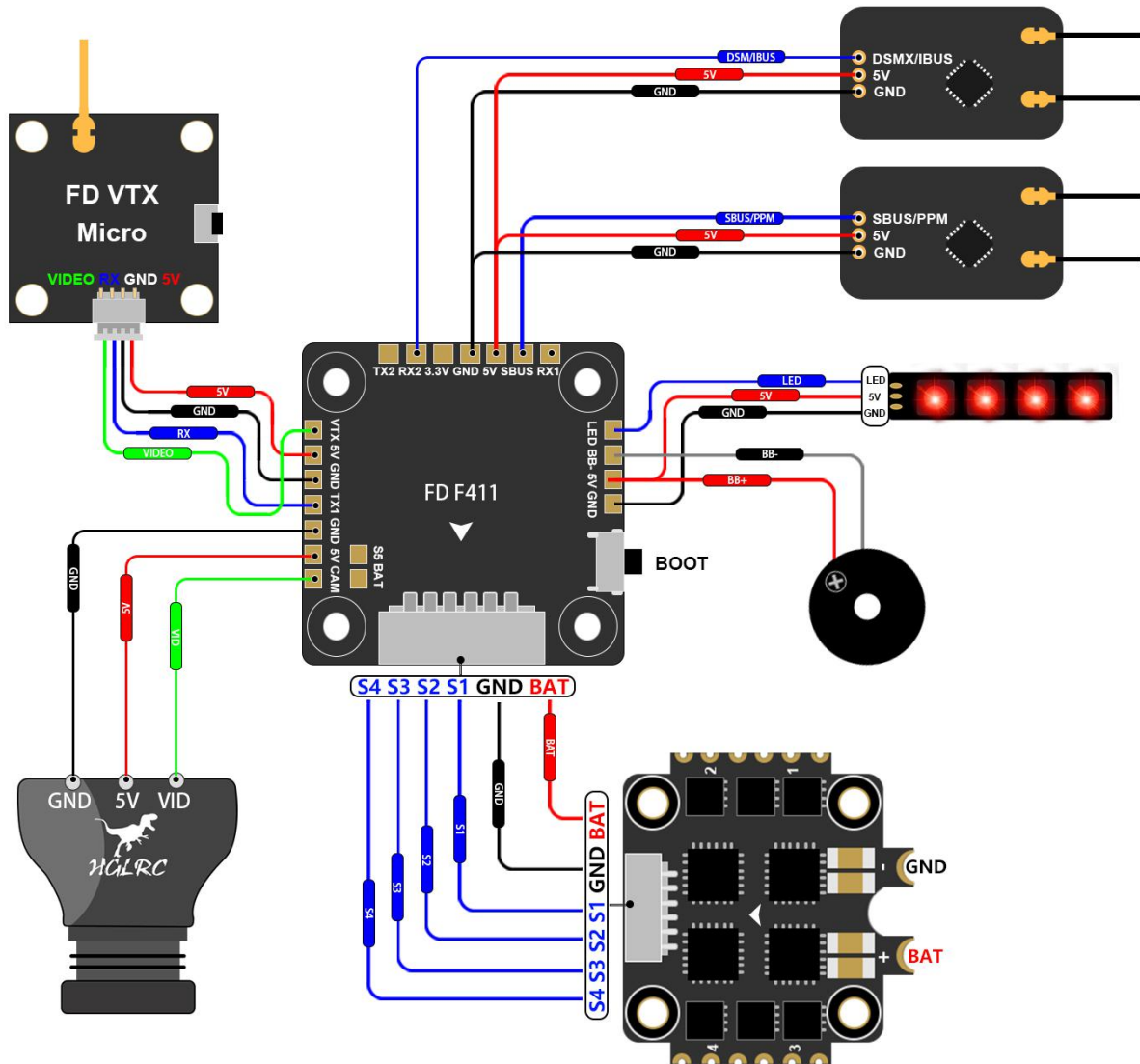

3. Check the flight control drive

1. Long Press BOOT buttons.connect USB.The system automatically install the driver



2.Driver cannot be installed, please download ImpulseRC_Driver_Fixer



3.Double-click on the run(Plug in the flight controller to automatically install the driver)

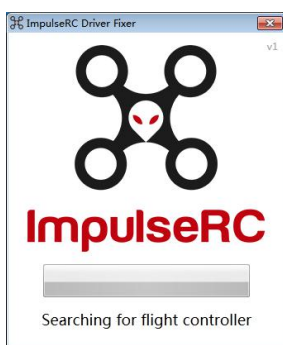



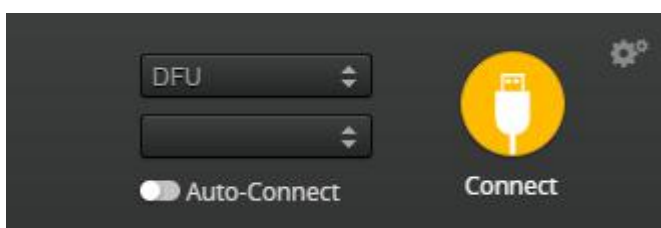

4.open betafight configurator , enter DFU mode

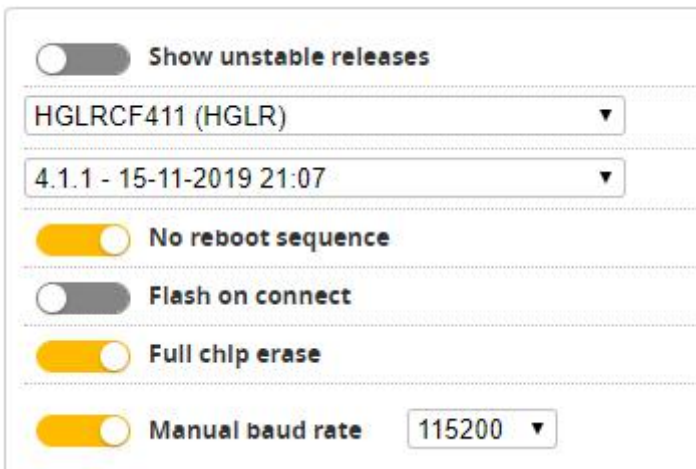

5. Click  Select firmware version



6. Click  Load firmware.  Waiting for completion  It will be prompted upon completion. 

7. open betaflyght configurator  . Controller plugged into the computer. Betaflight Automatically assigned port, click “Connect”
Enter setup interface (Different computer COM)



4. Calibration accelerometer

1. Put the aircraft horizontal and click “Reset Z axis”

Click again 

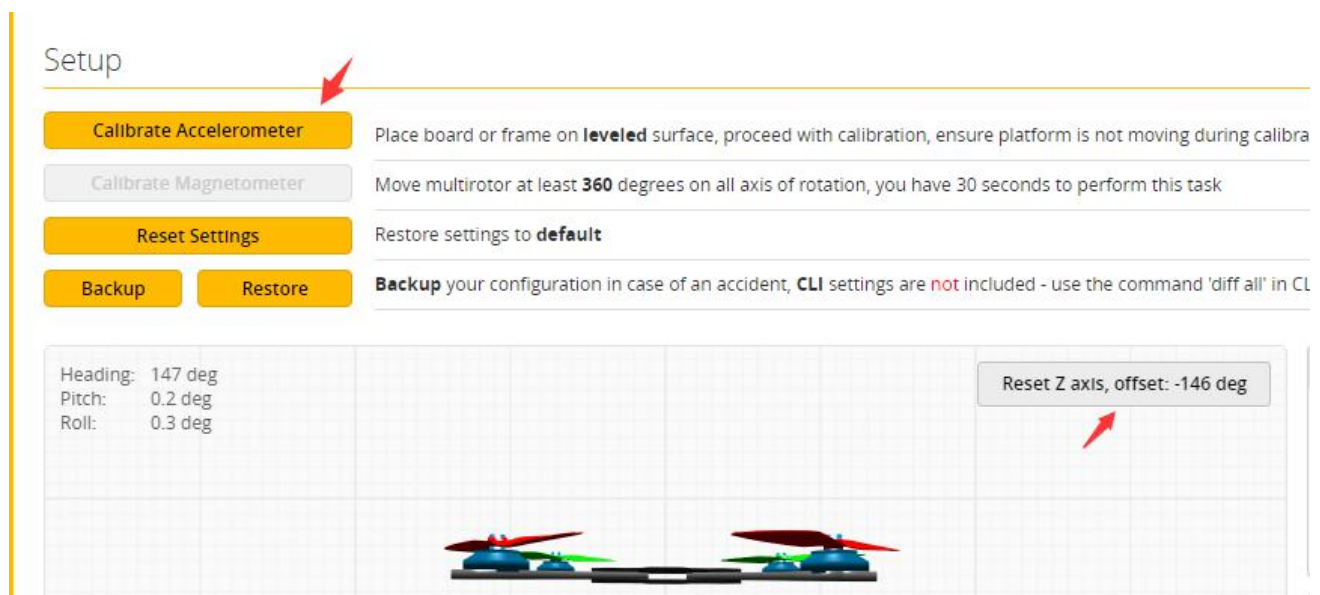

5. URAT serial port use

URAT1 uses VTX image transmission

UART2 uses receiver telemetry

6. Select aircraft model

1. Click  Configuration Select model

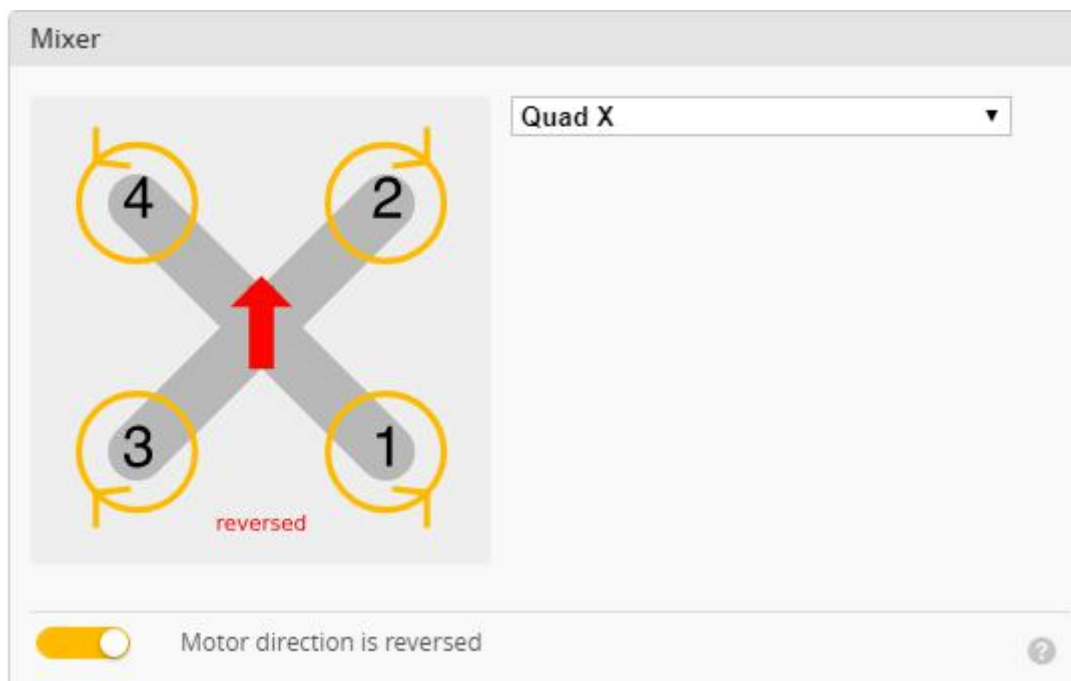

2. Click  Motors Click “**I understand the risks**” Push Master to check motor steering “**Master**” Steering can be changed at [BLHeliSuite](#)

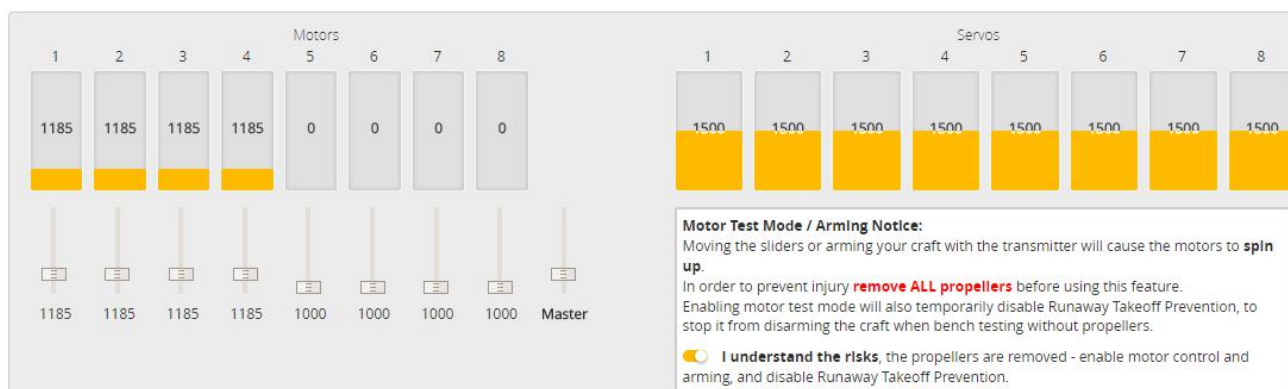

7. Choose ESC protocol

1. Choose the right ESC protocol, the optional universal protocol DSHOT600.

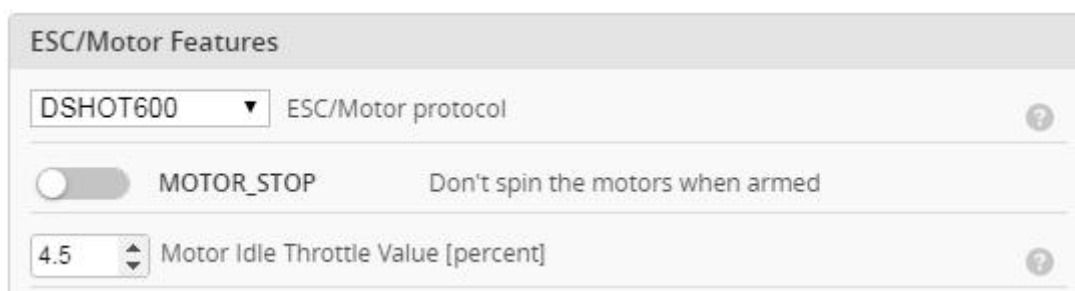

ESC/Motor Features

DSHOT600 ESC/Motor protocol

MOTOR_STOP Don't spin the motors when armed

4.5 Motor Idle Throttle Value [percent]

8. Voltage parameters setting

1. Click **Power & Battery** Setting parameters

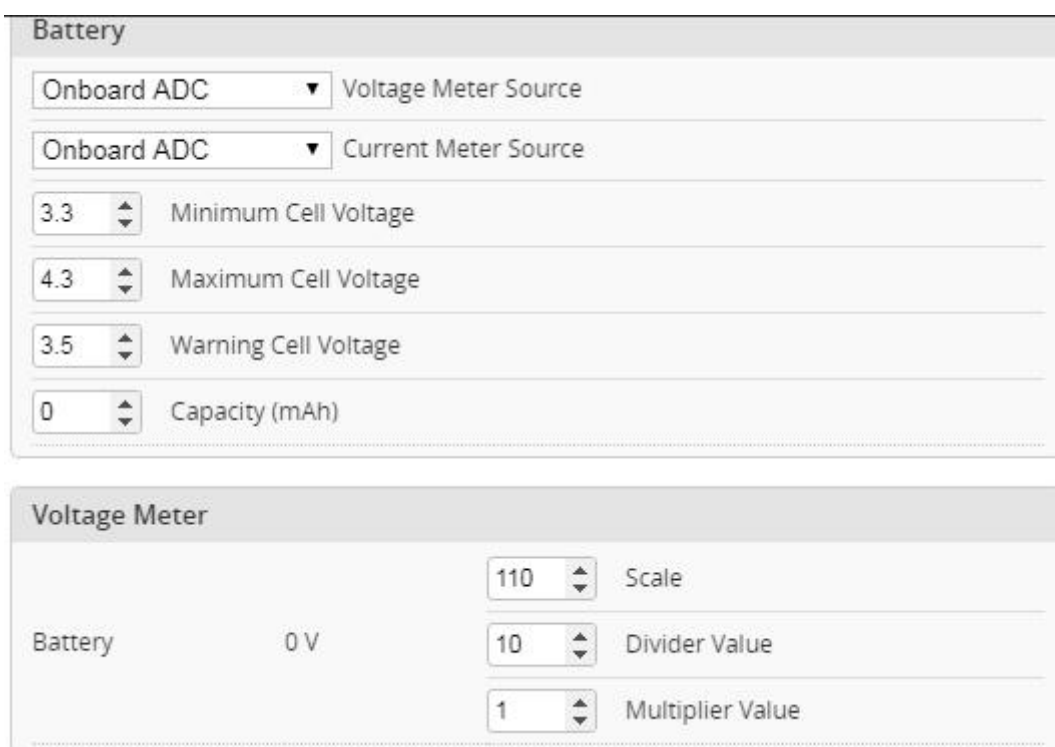

Battery

Onboard ADC Voltage Meter Source

Onboard ADC Current Meter Source

3.3 Minimum Cell Voltage

4.3 Maximum Cell Voltage

3.5 Warning Cell Voltage

0 Capacity (mAh)

Voltage Meter

Battery 0 V

110 Scale

10 Divider Value

1 Multiplier Value

9. Setting up the receiver

1. Receiver connection diagram

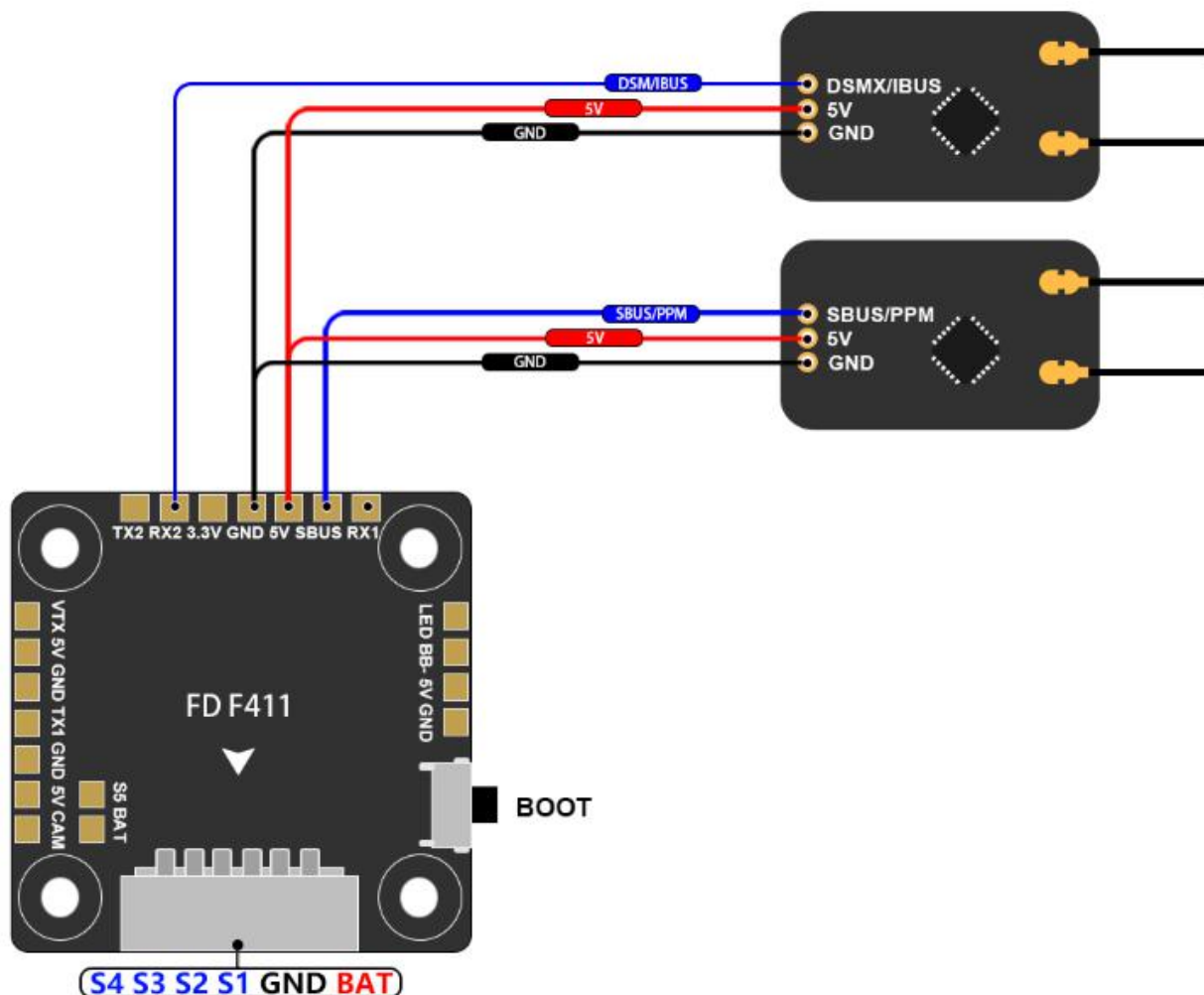

2. Click have found “UART2” Open (SBUS) the receiver serial port

Identifier	Configuration/MSP	Serial Rx	Telemetry Output	Sensor Input	Peripherals
USB VCP	<input checked="" type="checkbox"/> 115200	<input type="checkbox"/>	Disabled AUTO	Disabled AUTO	Disabled AUTO
UART1	<input type="checkbox"/> 115200	<input type="checkbox"/>	Disabled AUTO	Disabled AUTO	VTX (IRC Tran) AUTO
UART2	<input type="checkbox"/> 115200	<input checked="" type="checkbox"/>	Disabled AUTO	Disabled AUTO	Disabled AUTO

3. Open (i.BUS/DSMX) receiver serial port

Identifier	Configuration/MSP	Serial Rx	Telemetry Output	Sensor Input	Peripherals
USB VCP	<input checked="" type="checkbox"/> 115200	<input type="checkbox"/>	Disabled AUTO	Disabled AUTO	Disabled AUTO
UART1	<input type="checkbox"/> 115200	<input type="checkbox"/>	Disabled AUTO	Disabled AUTO	VTX (IRC Tran) AUTO
UART2	<input type="checkbox"/> 115200	<input checked="" type="checkbox"/>	Disabled AUTO	Disabled AUTO	Disabled AUTO

4. Set the **SBUS** receiver

Receiver

Serial-based receiver (SPEKSAT, S ▼) Receiver Mode

Note: Remember to configure a Serial Port (via Ports tab) and choose a Serial Receiver Provider when using RX_SERIAL feature.

SBUS Serial Receiver Provider

5. Set the **i.BUS** receiver

Receiver

Serial-based receiver (SPEKSAT, S ▼) Receiver Mode

Note: Remember to configure a Serial Port (via Ports tab) and choose a Serial Receiver Provider when using RX_SERIAL feature.

IBUS Serial Receiver Provider

6. Set the **DSMX** receiver

Receiver

Serial-based receiver (SPEKSAT, S ▼) Receiver Mode

Note: Remember to configure a Serial Port (via Ports tab) and choose a Serial Receiver Provider when using RX_SERIAL feature.

SPEKTRUM2048 Serial Receiver Provider

7. Set the **PPM** receiver

Receiver

PPM RX input Receiver Mode

10.VTX serial port use. VTX uses OSD smart audio

1.VTX connection diagram

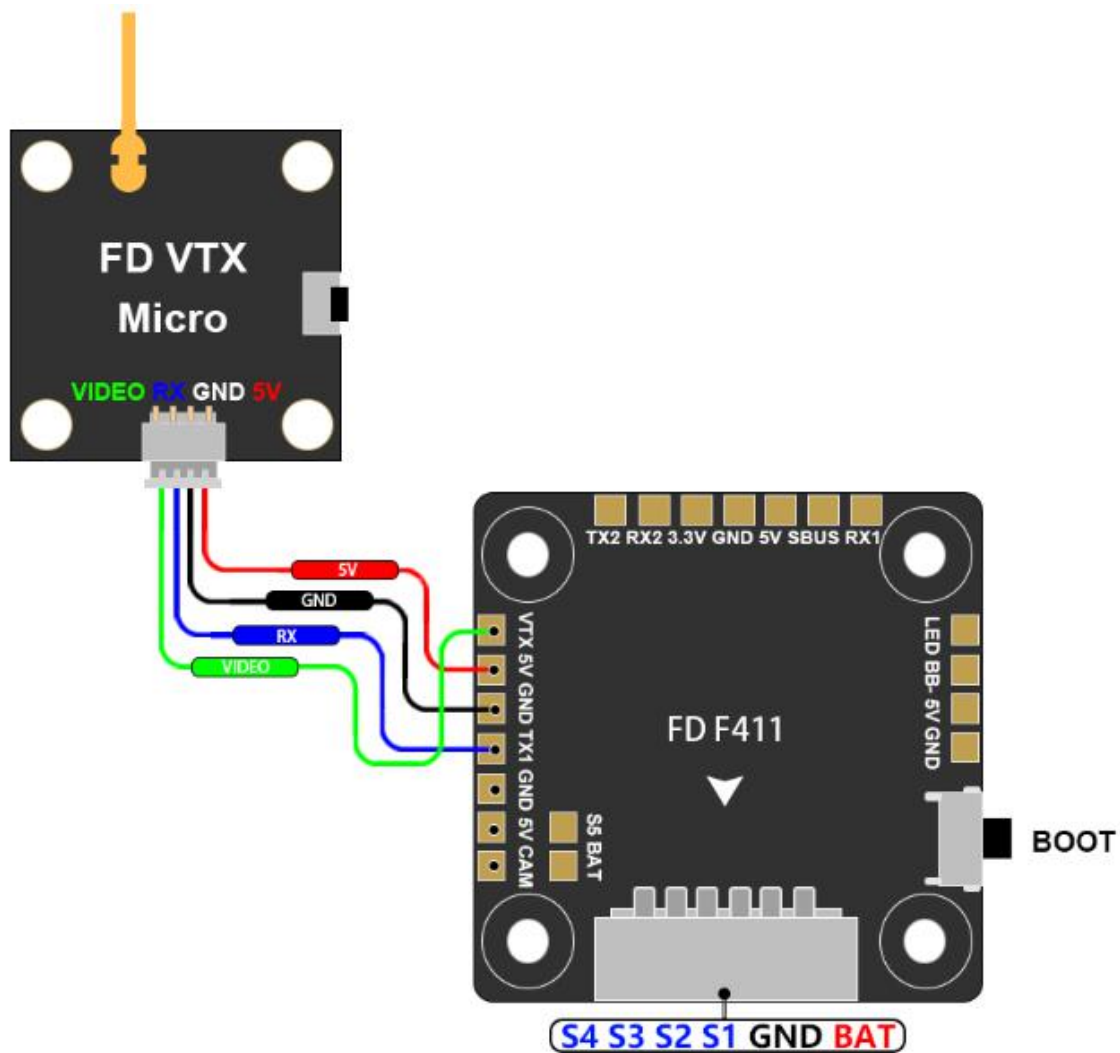

2.VTX serial port opens. The protocol is selected according to its own VTX protocol.

Identifier	Configuration/MSP	Serial Rx	Telemetry Output	Sensor Input	Peripherals
USB VCP	<input checked="" type="checkbox"/> 115200	<input type="checkbox"/>	Disabled AUTO	Disabled AUTO	Disabled AUTO
UART1	<input type="checkbox"/> 115200	<input type="checkbox"/>	Disabled AUTO	Disabled AUTO	VTX (IRC Tran AUTO
UART2	<input type="checkbox"/> 115200	<input checked="" type="checkbox"/>	Disabled AUTO	Disabled AUTO	<ul style="list-style-type: none"> Disabled Blackbox logging VTX (TBS SmartAudio) VTX (IRC Tramp) Camera (RunCam Protocol) Benewake LIDAR

3.Use OSD to adjust VTX

which displays information like battery voltage and mAh consumed while you fly. In addition, the Betaflight OSD can be used to configure the quadcopter, making in-field adjustments and tuning more convenient.

MODE2

MODE1

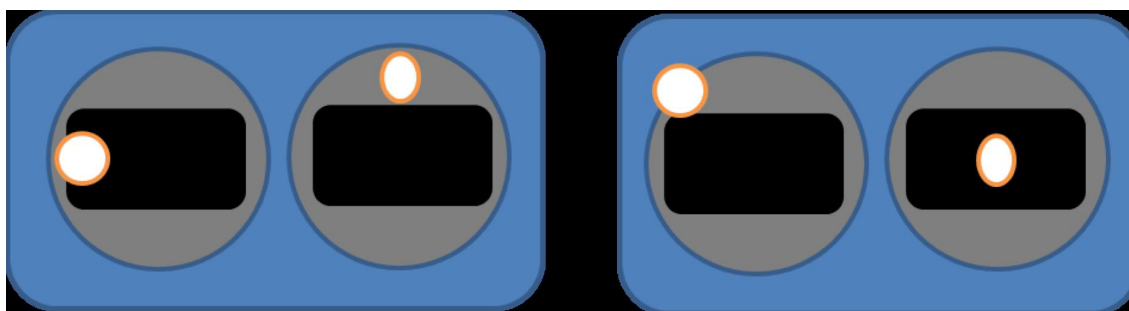

The graphics above show the stick command to bring up the OSD menu. The stick command is: throttle centered, yaw left, pitch forward. The exact stick command therefore depends on which mode your transmitter sticks are in.

In the OSD menu, use pitch up/down to move the cursor between menu items. When a menu option has a > symbol to the right of it, this indicates that it contains a sub-menu. Roll-right will enter the sub-menu. For example, in the screen to the right, moving the cursor to “Features” and then moving the roll stick to the right will enter the “Features” sub-menu.

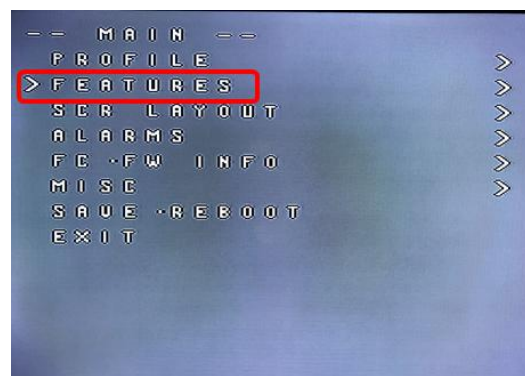



If you are using a video transmitter that supports remote configuration, enter the “Features” menu to configure the vTX. From there, enter either “VTX SA” if you are using SmartAudio (TBS Unify) or “VTX TR” if you are using IRC Tramp Telemetry.

To adjust PIDs, rates, and other tuning-related parameters, enter the “Profile” sub-menu.

In the “Scr Layout” sub-menu, you can move the OSD elements (like battery voltage, mAh, and so forth) around on the screen.

The “Alarms” sub-menu lets you control when the OSD will try to alert you that battery voltage is too low or mAh consumed is too high.

When a parameter can be modified, the parameter’s current value will be shown on the right-hand side of the screen. In this case, roll left/right will adjust the parameter up and down.

The screen to the right shows the current vTX settings. From here, you can change the frequency band, channel, and power level of the video transmitter. After making the changes, move the cursor to “Set” and press roll-right to confirm the settings.

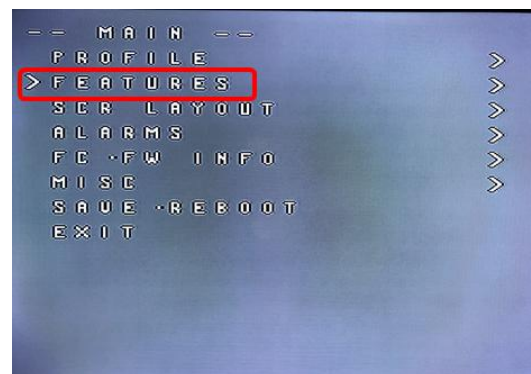
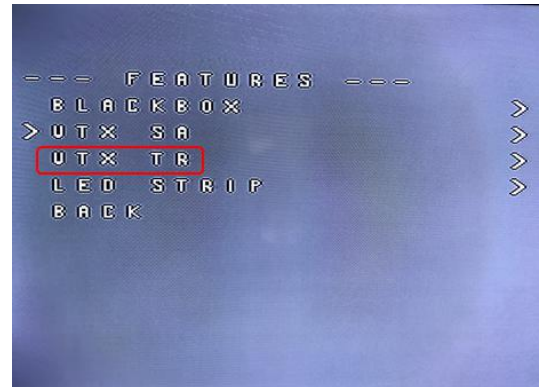

11. Check receiver signal

1. Click  Receiver Check the remote control output signal

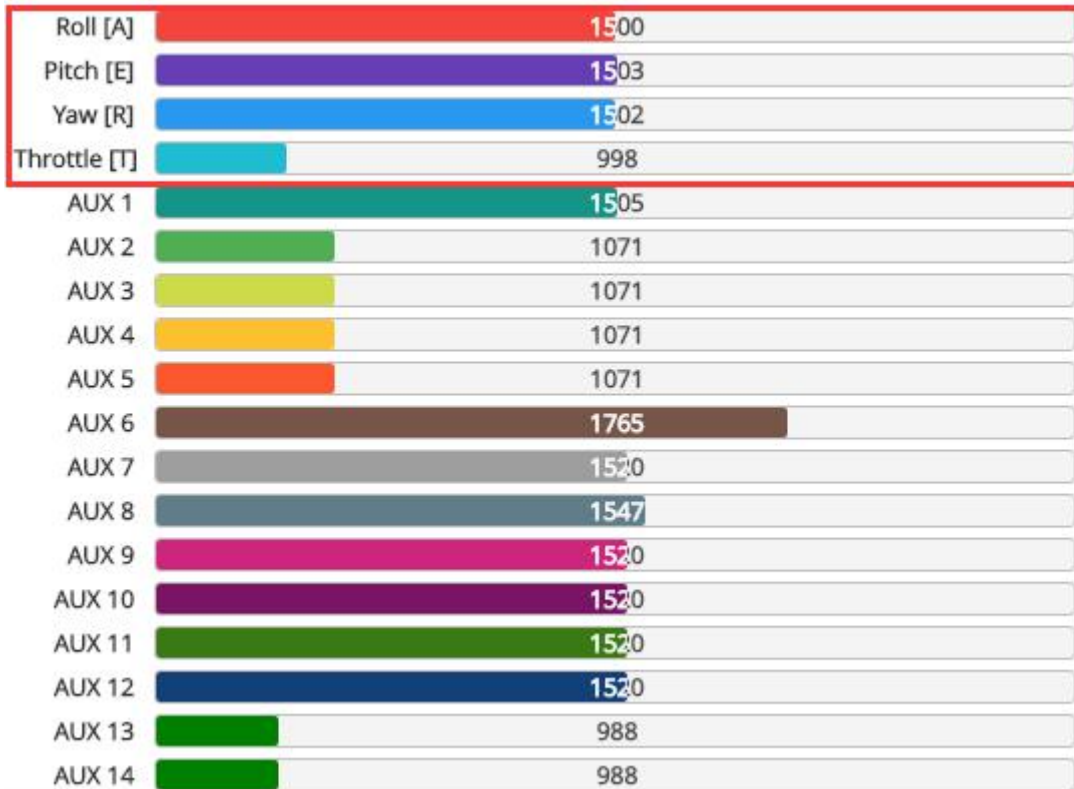

12. Select flight mode startup mode

1. Click  Modes set up the function of remote control switch across the channel (below are for reference only)

Modes WIKI

Use ranges to define the switches on your transmitter and corresponding mode assignments. A receiver channel that gives a reading between a range min/max will activate the mode. Remember to save your settings using the Save button.

Show/hide unused modes

ARM	AUX 1	Min: 1300 Max: 2100	900 1000 1200 1400 1500 1600 1800 2000 2100
ANGLE	AUX 1	Min: 1300 Max: 2100	900 1000 1200 1400 1500 1600 1800 2000 2100

13.OSD settings

1. Click  the OSD Settings, according to the need to choose, drag the OSD schematic diagram of the parameters can be adjusted.



The screenshot displays the OSD settings interface, which is divided into several sections:

- Elements:** A list of 15 items with toggle switches. The 'Main Batt Voltage' item is currently selected (checked).
- Preview (drag to change position):** A central window showing a live video feed of a drone in flight. The text 'BETAFLIGHT' is overlaid in the upper center, and 'LOW VOLTAGE' is overlaid in the lower center. A battery icon in the bottom left corner shows '16.8V'.
- Video Format:** Radio buttons for 'AUTO' (selected), 'PAL', and 'NTSC'.
- Units:** Radio buttons for 'IMPERIAL' and 'METRIC' (selected).
- Timers:** Two timer entries. Entry 1 has a source of 'ON TIME', precision of 'SECOND', and an alarm of '10'. Entry 2 has a source of 'TOTAL ARMED TIME', precision of 'SECOND', and an alarm of '10'.

14.LED settings

1. Click  Configuration Turn on LED support



2. Click  LED Strip. Click  set according to need

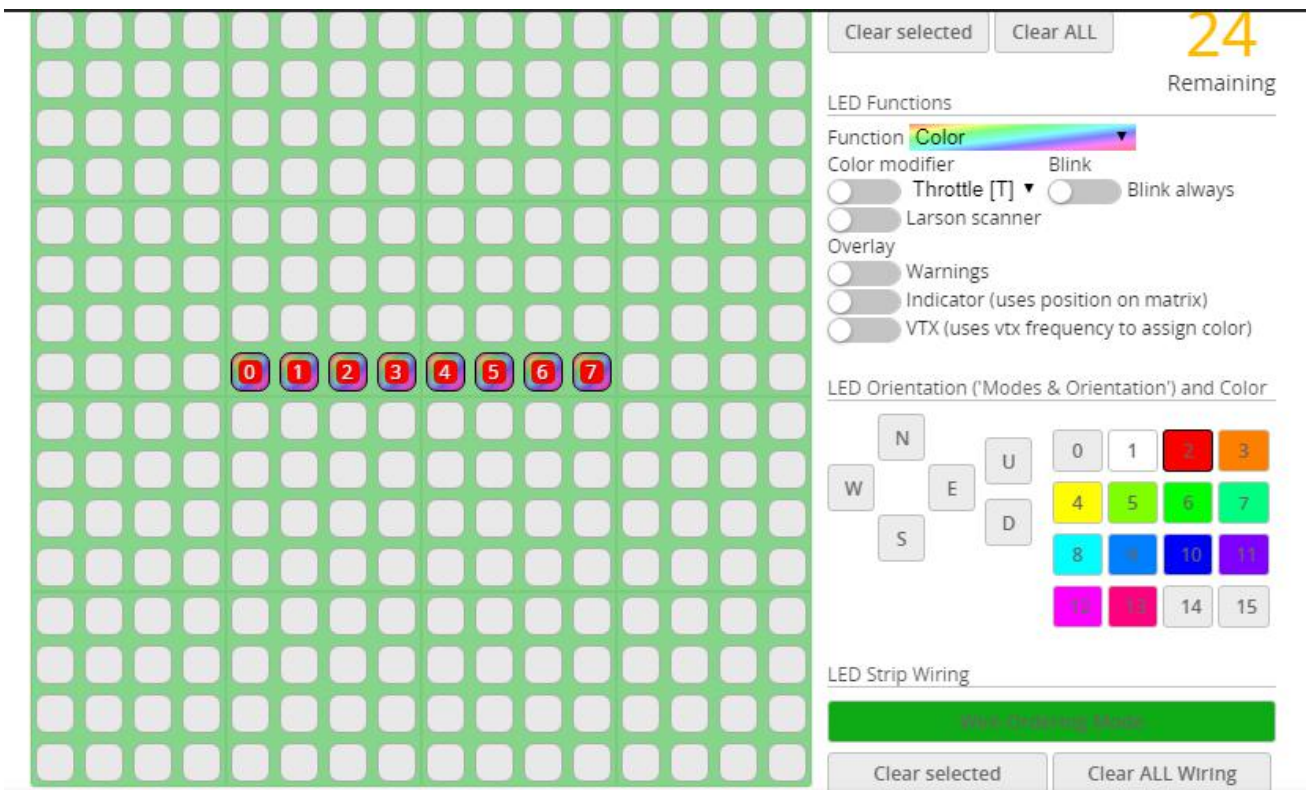

Clear selected Clear ALL **24** Remaining

LED Functions

Function **Color**

Color modifier Throttle [T] Blink always

Larson scanner

Overlay

Warnings

Indicator (uses position on matrix)

VTX (uses vtx frequency to assign color)

LED Orientation ('Modes & Orientation') and Color

N	U	0	1	2	3
W	E	4	5	6	7
S	D	8	9	10	11
		12	13	14	15

LED Strip Wiring

Wire Ordering Mode

Clear selected Clear ALL Wiring

15. Troubleshooting

Warning:

Please read the cautions as follows, otherwise stability of your flight controller cannot be ensured, your flight controller will even get damaged.

- Keep focus on the polarity. Check carefully before power supply.
- Cut off the power when you connect, plug and pull anything.
- The refresh rate of PID and Gyroscope is up to 8K/8K.

after sales question:

1. After receiving the goods, it is found that the product can not be used normally. If the return to the factory is a quality problem, the repair service will be provided free of charge.
2. If the product is damaged due to improper operation, the repair service may be provided under the condition that the inspection can be repaired.
3. For domestic customers, please contact the after-sales service personnel. For overseas customers, please contact the official website for after-sales service.

Product daily problems

1.OSD garbled:

If you find garbled characters, please open Betaflight, click “OSD” .and click “Font Manager” clicks on “Upload Font” to update

1. When plugged in the battery, the aircraft does not pass the self-test without "BBB" sound. There is only one sound.

Please check if the ESC agreement is correct

3.The spin of the aircraft keeps spinning

1. Please check if the propeller is correct
2. Please check if the motor direction is correct