



InDTU332 & 324

USER MANUAL

Version: V1.0 - November, 2019

InHand Networks
Global Leader in Industrial IoT

Declaration

Thank you for choosing our product. Before using the product, read this manual carefully.

The contents of this manual cannot be copied or reproduced in any form without the written permission of InHand.

Due to continuous updating, InHand cannot promise that the contents are consistent with the actual product information, and does not assume any disputes caused by the inconsistency of technical parameters. The information in this document is subject to change without notice. InHand reserves the right of final change and interpretation.

© 2019 InHand Networks. All rights reserved.

Conventions

Symbol	Indication
< >	Content in angle brackets "<>" indicates a button name. For example, the <OK> button.
""	"" indicates a window name or menu name. For example, the pop-up window "New User."
>	A multi-level menu is separated by the double brackets ">". For example, the multi-level menu File > New > Folder indicates the menu item [Folder] under the sub-menu [New], which is under the menu [File].
Cautions	Means reader be careful. Improper action may result in loss of data or device damage.
Note	Notes contain detailed descriptions and helpful suggestions.

Contact Us

Add: 3900 Jermantown Rd., Suite 150, Fairfax, VA 22030 USA

E-mail: support@inhandnetworks.com

T: +1 (703) 348-2988

URL: www.inhandnetworks.com

Contents

1 Product Overview	1
1.1 System Application	1
1.2 Function Description	1
1.2.1 Hardware	1
1.2.2 Software Functions	2
2 Quick Start	5
3 Hardware description	6
3.1 Installation	6
3.1.1 InDTU332	6
3.1.2 InDTU324	8
3.2 LED Indicator	9
3.2.1 InDTU332	9
3.2.2 InDTU324	10
4 Configurations	11
4.1 Wiring	11
4.2 Connecting the DTU to the Master Station	11
4.3 TCP Server	16
4.4 Modbus-Net-Bridge	19
4.5 Multi-application Center	21
4.6 Connecting the DTU to the DM Cloud Platform	22
4.7 Transmission Mode	24
4.8 ICMP/Link Maintenance Function	24
4.9 Dual-SIM Switching Function	26
4.10 Maintenance	30
4.10.1 View Real-Time/ History Logs	30
4.10.2 101 Detection	33
4.11 Other Functions	35
4.11.1 Login Settings for the Administrator	35
4.11.2 Import/Export Configuration	35
4.11.3 Upgrade Device	36
4.11.4 Power Mode	39
4.11.5 Restoring Factory Settings	39
4.11.6 SNTP Time Synchronization	40
4.11.7 Short Message Sending/Receiving	41
5 FAQ	44
6 Parameter Settings	46

6.1 Local Serial Port/Serial Port 2	46
6.2 Work Mode	47
6.3 GPRS Dialing	48
6.4 Application Center	48
6.5 Multi-application Center	49
6.6 Multi-center mechanism	50
6.7 Other Settings	50
6.8 InHand Device Manager (DM) platform	51
6.9 Administrator Account	51
6.10 ICMP	52
6.11 User-Defined Packets	53

1 Product Overview

1.1 System Application

InDTU332/324 uses the wireless cellular network to complete remote data collection and transmission, thus enabling remote monitoring in the industrial field. The typical network topology is shown as below.

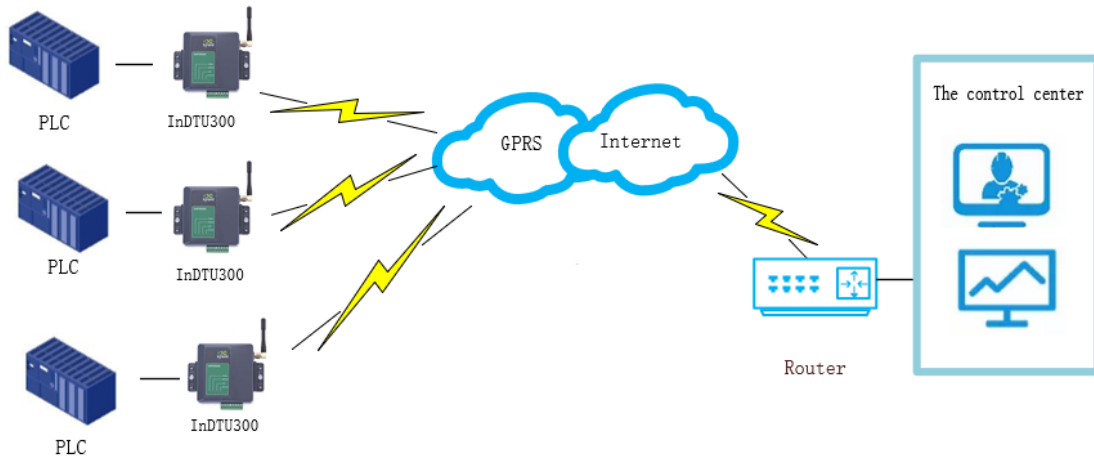

Figure 1-1-1 network topology

1.2 Function Description

1.2.1 Hardware

It has the following features:

- It is based on a high-performance microprocessor that integrates a wireless module for wireless communication.
- It supports a variety of industrial bus protocols, with good scalability.
- Compact and easy-to-install design
- Moisture proof, anti-interference design
- Voltage range +5 to 35 V DC, meeting industry requirements
- Industry-level temperature range: -40°C to +70°C

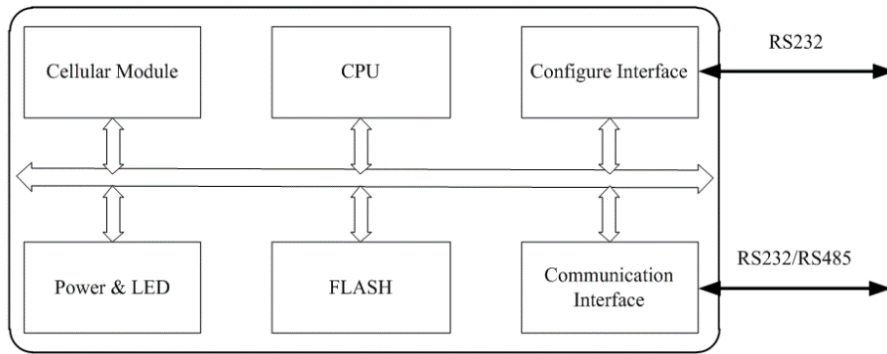

Figure 1-2-1 hardware structure

1.2.2 Software Functions

DTU332/324 implements wireless data communication between the serial port device in the remote station and the central control system. The main functions are as follows:

Table 1-2-1 Basic functions

Function	Description
Network	Wireless cellular network
Serial port	Special configure tool is DTU Tool, can configure DTU by any of serial port
Status	Displays running status using LED.
Mounting mode	Desktop installation or wall-mounting
Wireless DDN	Supports the wireless DDN service of China Mobile and the VPDN service of China Telecom and China Unicom.
Data transparent transmission	Transmits application data transparently in two directions.
Protocol conversion	Custom UDP for DC and Modbus bridge
Long connection	DTU will actively dial up and establish a PPP link.
Short connection	DTU does not actively dial up and establish a PPP link. According to different configurations, there will be different activation policies, and dialing and networking will start after activation.
Local data active	In short connection mode, the network can be activated via local data transmission when the device is in hibernation
Phone active	In short connection mode, when the device is in hibernation, the network can be activated by phone call.
Auto active	Start timing when entering sleep mode, reach the scheduled time, then re-dial up
Auto offline	Start timing from the successful dialing, and when the scheduled time is reached, restart the communication module and enter the sleep mode.
Log	Enables the log function to output logs through the serial port, helping

	engineering personnel observe the device running status.
Multi-serial port communication speed	Baud rate: 1200-115200 bps
RS 232/485	Supports RS 232/485 communication. Depends on the device model.
Software watchdog	Prevents accidental crash.
Hierarchical user authentication	Supports two user levels: administrator and common user. Default administrator user name/password: adm/123456; Common user name/password: guest/123456.
Real-time clock	Upon power-off, a built-in super capacitance powers the RTC to avoid the loss of system time. The power must persist for more than two hours; otherwise, the clock is restored to the system time. Only some models support this function.
Factory settings restoration	Clears settings and writes default settings. This function is implemented by configuration program.

Table 1-2-2 Network functions

Function	Description
PPP	Point-to-point dialing protocol.
CHAP	Authentication mode.
PAP	Authentication mode.
Automatic authentication.	Uses PAP and CHAP in turn. When a client requests to go online, DTU performs PAP authentication first. If the authentication fails, DTU performs CHAP authentication. If the authentication fails again, DTU performs PAP authentication. The preceding procedures are repeated.
PPP echo	Maintains the connection between DTU and carrier network, preventing forcible dormancy and detecting the stability of dialing connection.
ICMP detection	Maintains the connection between DTU and peer host.
Application layer echo	Detects the connection with application server by monitoring the heartbeat at application layer. Eg. TCP keep-alive or user-define packet.

Table 1-2-3 Advanced functions

Function	Description
Upgrade	Locally upgrade by serial port or remotely upgrade by IP network
Import/export	Exports configuration to files or imports configure file to device.
Log storage	Stores key logs to the Flash memory, which can be read by using configuration tool or serial port.
DM remote network	Once enables the DM function, Through the DM platform, you can read and

management	update its configurations, read device status, perform remote upgrade, and locate the base station.
RTOOL	Remotely update the DTU firmware or configuration by RTool. The network should be accessed between RTool side and DTU when using this function.
55 AA command	Please refer the IHDMP user manual
Short message management	Supports remote configuration, forcible login, status query, and reboot.
Multi-center	Supports multiple IP centers in poll or parallel mode. The application center IP center must be configured firstly, and then configure the extended center in sequence.
Link maintenance	To avoid network congestion caused by the problem of the operator network optimization parameters, a byte of IP packets is sent to the detection host every network idle interval after this function is enabled. (This function is applicable only to V1.4.3 and later versions.)



Caution

The DM platform, for the use scenarios of the mainland and overseas, the corresponding domain names are <http://c.inhand.com.cn> and <http://g.inhandnetworks.com>; the platform also supports setup or install on the client's private server.

2 Quick Start

The procedure for quickly starting the InDTU as a client is as follows:

1. Correctly insert the SIM card.
2. Correctly connect the power cable, RS232/485 serial cable, and antenna.
3. Correctly configure the DTU parameters, including the IP address, APN, and port number.
4. Enable the DTU to communicate with the master station and read data from the terminal. For details, see section [4.2 "Connecting the DTU to the Master Station"](#).
5. Restart the device for the configurations to take effect.
6. Browse, count, and analyze data by using user software of the master station, such as DM cloud platform software.

3 Hardware description

3.1 Installation

3.1.1 InDTU332

DTU332 is housed in a snap-type plastic shell. Figure 3-1-1 shows:



Figure 3-1-1

Open the case, slide the top cover, insert the SIM card correctly, and then close the top cover, as shown in Figure 3-1-2.



Figure 3-1-2 Installing SIM card into DTU332

Connect the antenna, the cables for serial interface and DC power cable, as shown in Figure3-1-2.

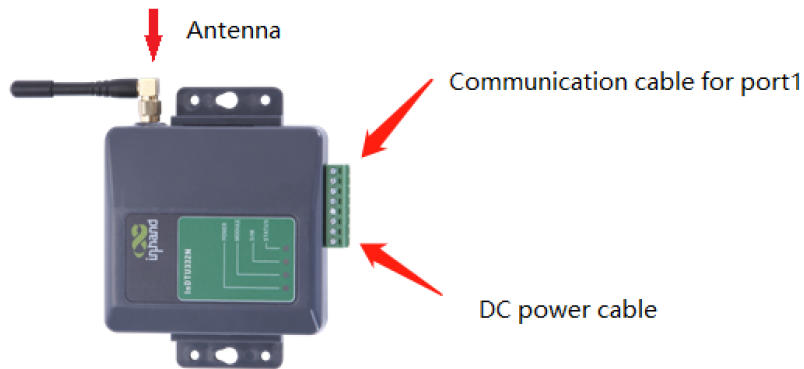

Figure3-1-3 DTU332 wiring

Table 3-1-1 Interface terminal description

Pin	Function	Remarks
GND	Digital ground	Provide serial port grounding.
TXD/485-	RS232 sending or RS485-	Data sending port of serial port 1
RXD/485+	RS232 receiving or RS485+	Data receiving port of serial port 1
RXD2	RS232 data receiving	Data receiving port of serial port 2
TXD2	RS232 data Transmitting	Data sending port of serial port 2
GND	Digital ground	Provide serial port grounding.
V-	Power Negative	Support 5 V DC to 35 V DC input, with ripple wave lower than 100 mV.
V+	Power Positive	

The interface terminal of DTU332 is shown as below:



Figure 3-1-4 DTU332 interface

3.1.2 InDTU324

Step 1: Install the SIM card. Press and hold the ejection button of the SIM card holder to eject it, and install the SIM card, as shown in Figure 3-1-5.



Figure 3-1-5 Installing the SIM card of the InDTU324

Step 2: Install the antenna. Gently rotate the movable part of the metal SMA-J connector to the end with your hand, until the external threads of the antenna connection wire cannot be seen. Do not hold the black rubber sleeve and twist the antenna forcibly. See Figure 3-1-6.

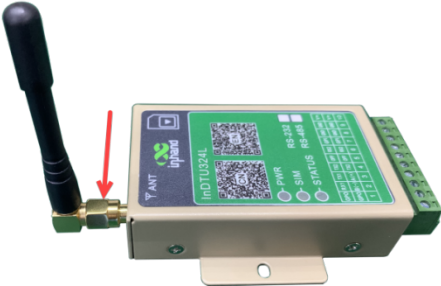

Figure 3-1-6 Installing the antenna of the InDTU324

Step 3: Connect the terminal wires. Remove the terminal from the device during installation, loosen the locking screws on the terminal, connect the corresponding wires to the terminal, and tighten the screws, as shown in 3-1-7.

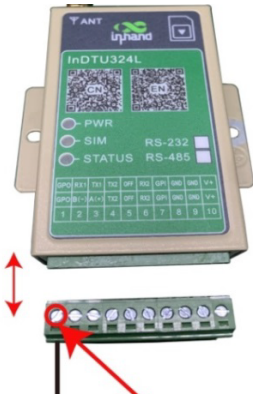

Figure 3-1-7 Order of terminal wires of the InDTU324

There are two terminal wire sequences depending on the product models: RS-232 and RS-485.

Table 3-1-2 Two terminal wire sequences of the InDTU324

Pin	Signal Name		Description
RS-232/RS-485 Pin Definition			
1	GPO		General GPIO port for indicating the online and offline states of the DTU
2	RX1	B (-)	DTU serial port 1 for receiving data (RS232-/RS485-)
3	TX1	A (+)	DTU serial port 1 for sending data (RS232+/RS485+)
4	TX2		DTU serial port 2 for sending data
5	OFF		Power control: disabled at a high level (3.0–10 V) and enabled at a low level (0–0.3 V) or in the suspended state
6	RX2		DTU COM port 2 for receiving data
7	GPI		General GPIO port, reserved
8	GND		DGND for COM port grounding
9	GND		Negative pole of power input
10	V+		Positive pole of power input

3.2 LED Indicator

3.2.1 InDTU332

InDTU332 has 3 indicator lights: POWER (red), SIM (yellow), STATUS (green); POWER: the equipment should be kept on after POWER on; SIM and STATUS lights: indicate the working STATUS of DTU.

DTU STATUS	POWER	SIM	STATUS
Power on	On	Off	Off
Dialing..., no fault.	On	Off	Off
Dialing..., fault.	On	Off	On
Dialing is successful, and connecting the center.	On	On	Off
Dialing is successful, but failed to connect to the center.	On	On	On
Connected to the center.	On	Blinking slowly with the same frequency	
When DTU is used as TCP Server, if any client connection succeeds	On	Blinking slowly with the same frequency	

Short connection to be activated.	On	Off	Blinking slowly
SIM card is faulty.	On	Blinking slowly	On
In TROY mode.	On	Blinking fast alternatively	

3.2.2 InDTU324

InDTU324 has 3 indicator lights: POWER (red), SIM (yellow), STATUS (green); POWER: the equipment should be kept on after POWER on; SIM and STATUS lights: indicate the working STATUS of DTU.

DTU STATUS	POWER	SIM	STATUS
Power on	On	Off	Off
Dialing..., no fault.	On	Off	Off
Dialing..., fault.	On	Off	On
In AT/TROY mode.	On	Flash alternately	
Dialing is successful, and connecting the center.	On	On	Off
Short connection to be activated.	On	Off	Blinking slowly
Dialing is successful, but failed to connect to the center.	On	On	On
Connected to the center.	On	Blinking slowly with the same frequency	
When DTU is used as TCP Server, if any client connection succeeds	On	Blinking slowly with the same frequency	
SIM card is faulty.	On	Blinking slowly	On

4 Configurations

4.1 Wiring

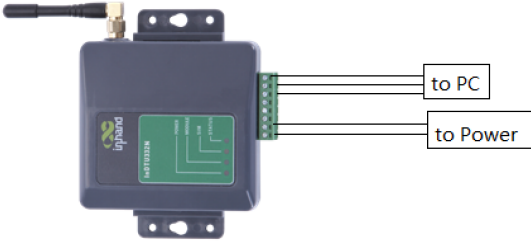

Figure 4-1-1 DTU332 wiring

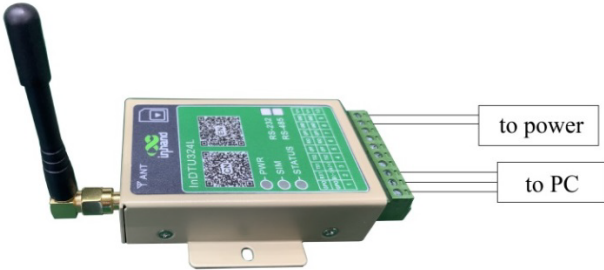

Figure 4-1-2 DTU324 wiring

4.2 Connecting the DTU to the Master Station

Step 1: Access the **Device Manager** UI of the PC and record the COM number of the serial port to which the PC is connected.

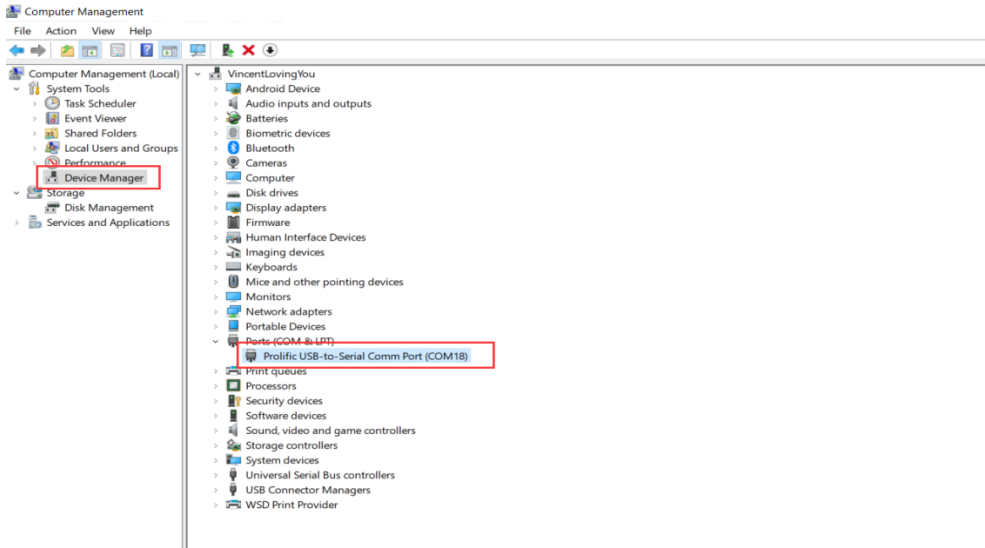



Figure 4-2-1 Viewing the COM number

Step 2: Connect the device and enable the DTU tool 

Click **Connect**, enter the user name and password (**adm/123456** by default), select the recorded COM number, check **Automatic**, and click **Connect**, as shown in Figure 4-2-2.

Modify the configuration parameters after the "Configuration read succeeded" message is displayed, as shown in Figure 4-2-3.

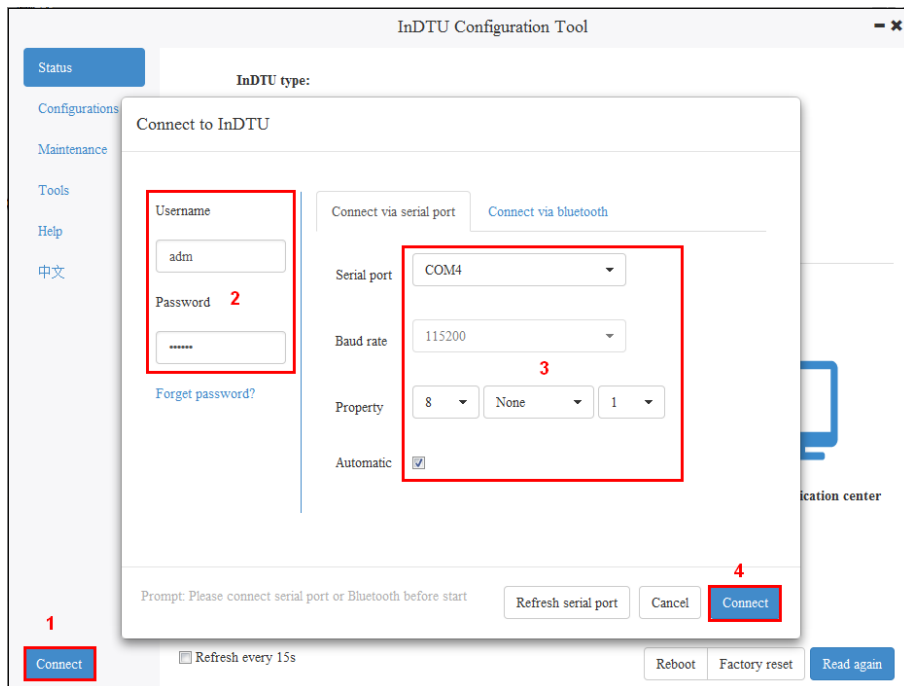

Figure 4-2-2 Logging in to the configuration tool

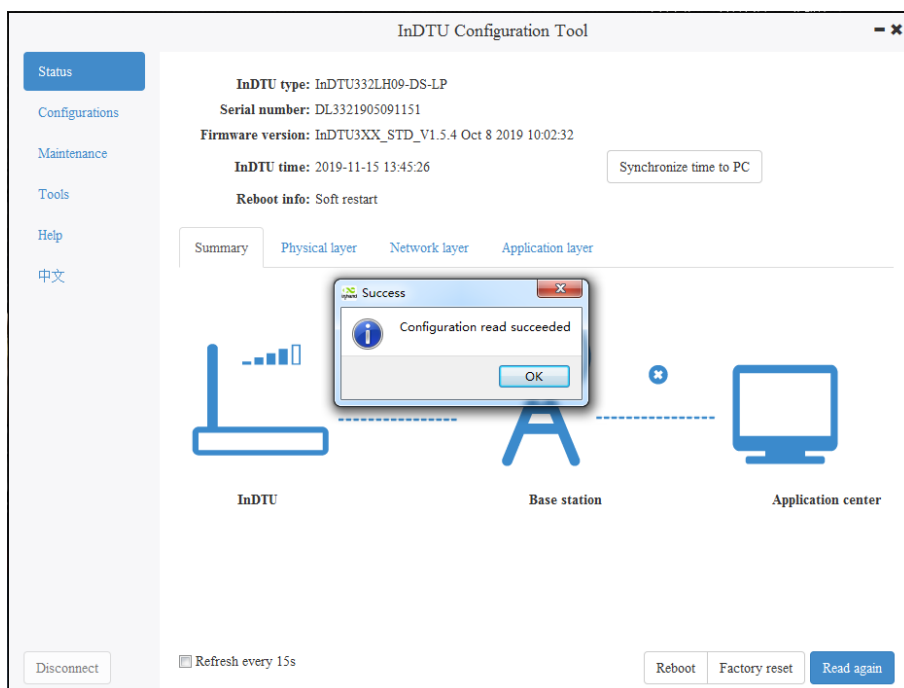

Figure 4-2-3 "Configuration read succeeded" displayed on the UI

(Optional) Step 3: Choose **Configurations > All Configurations setting > Serial port 1 setting/Serial port 2 setting**.

Set the serial port parameters of the InDTU, which must be the same as those of the connected device, as shown in Figure 4-2-4.

Set the parameters of serial port 1 when the InDTU acts as a client, and set the parameters of serial port 2 when the InDTU acts as a server:

Default settings of serial port 1: 9600, 8, None, 1; default settings of serial port 2: 115200, 8, None, 1.

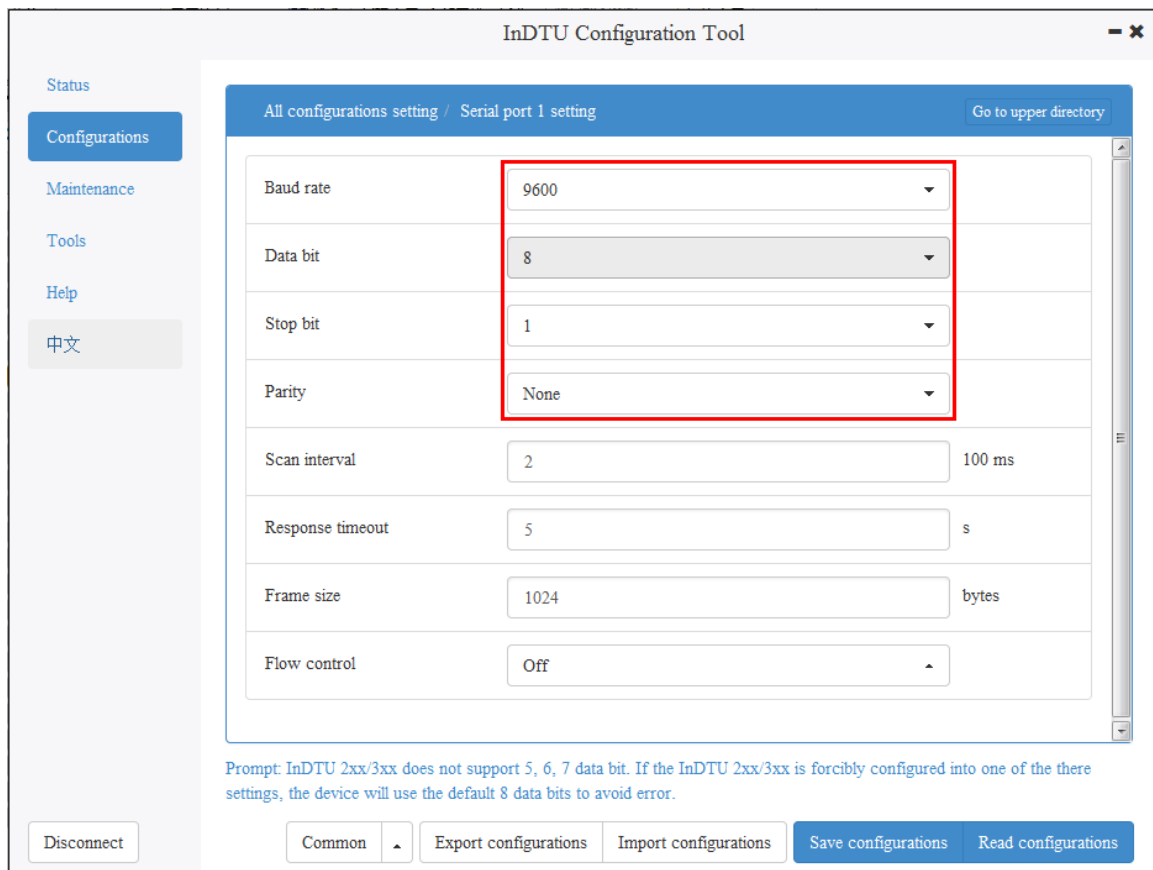

Figure 4-2-4 Setting the parameters of the local serial port

Step 3: Choose **Configurations > All Configurations setting > Dial parameters setting**.

Enter the APN provided by the SIM card operator and the network dial username/password, as shown in Figure 4-2-5.

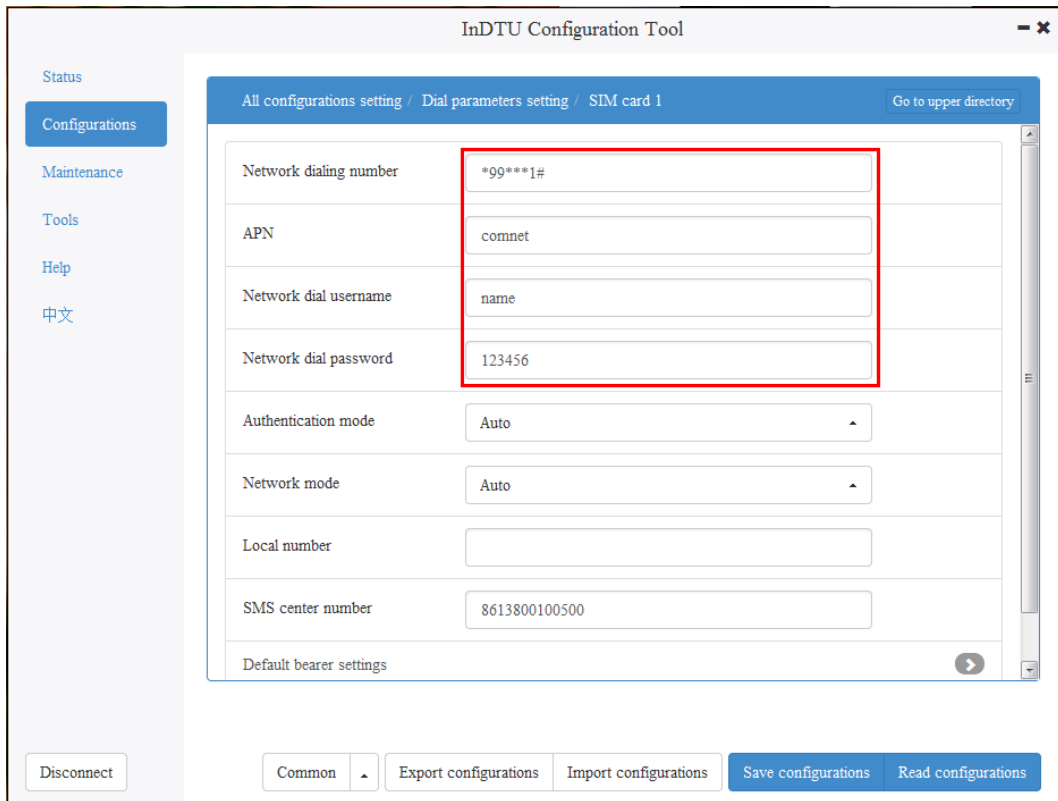

Figure 4-2-5 Set SIM card parameters

Step 4: Select a transparent transmission protocol.

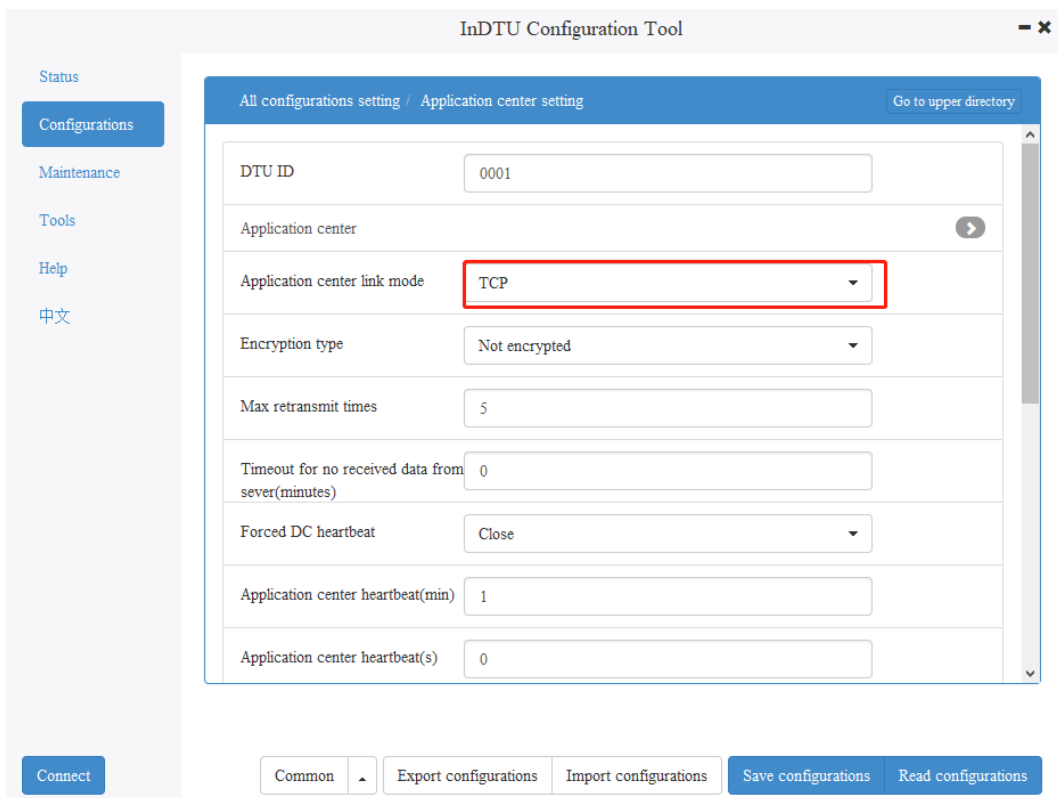

Figure 4-2-6 Selecting a connection protocol

In step 4, If UDP is selected, **user-defined packets** must be set.

You can customize the login, heartbeat, and logout packet type and content.

There are three types of packets: ASCLL, HEX, and DC. **In a HEX-type packet, a space is counted as a byte. In an ASCLL-type packet, spaces are not counted as bytes. A packet contains a maximum of 32 bytes. If the DC type is selected, the packet content does not need to be configured.**

Choose **Configurations > All Configurations setting > User defined packets setting**, select the type of packets to be defined, and define the packet content, as shown in Figure 4-4-7 and Figure 4-4-8.

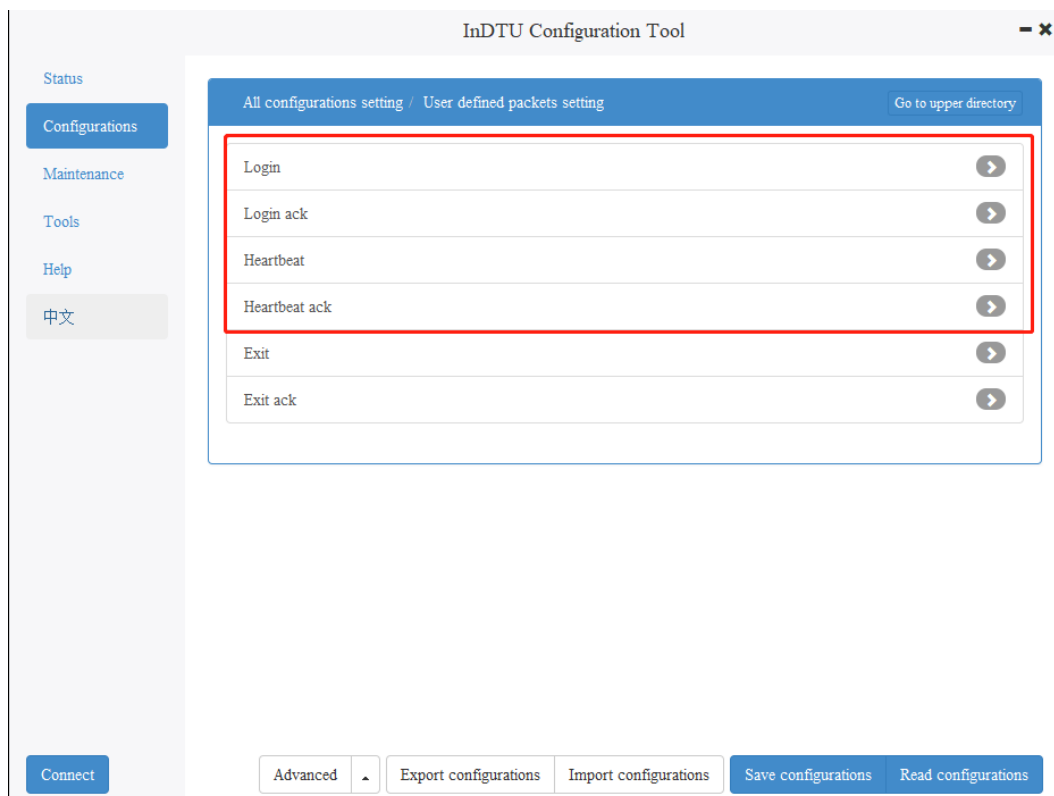

Figure 4-4-7 User defined packets setting (1)

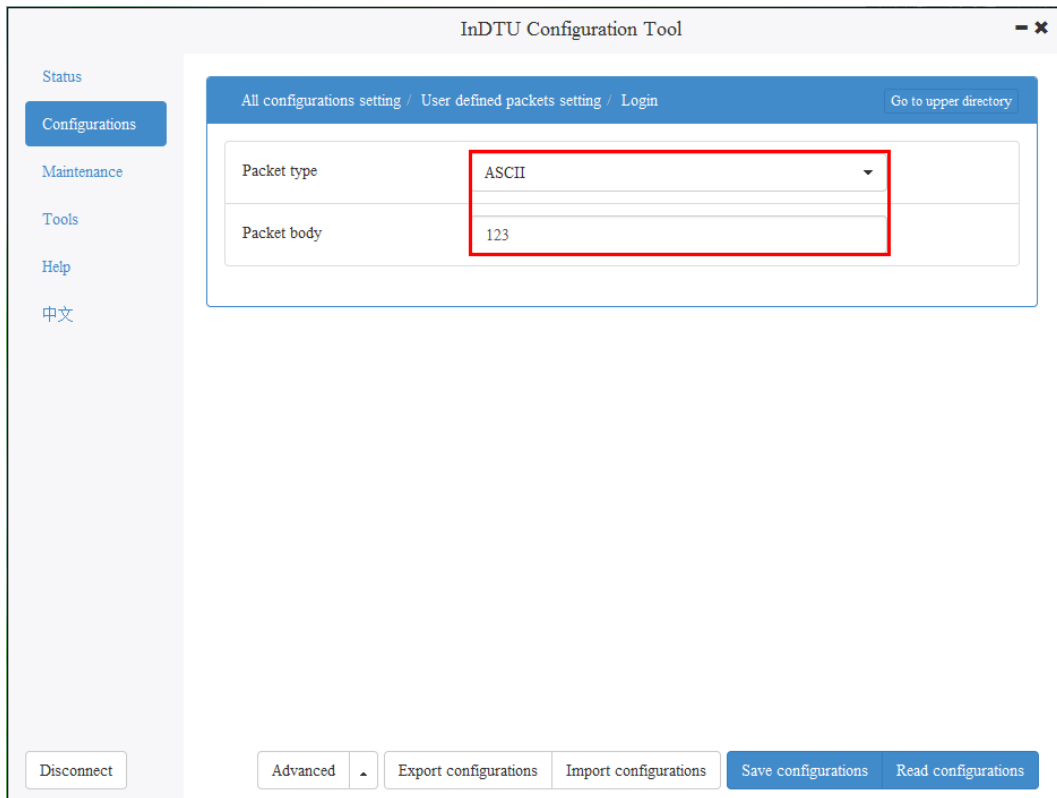

Figure 4-4-8 User defined packets setting (2)

4.3 TCP Server

When the GPRS DTU works as a TCP server, note that:

- The DTU must have a fixed IP address. That is, the wireless DDN private network service is required.
- The DTU detects link availability by monitoring the wireless side data. If there is no data from the wireless side in two hours (this interval cannot be set), GPRS disconnects the PPP link and redials.

Step 1: Choose **Configurations > All Configurations setting > Application center setting**.

Set **Local TCP server port** (for example, to **21022**), as shown in Figure 4-3-1.

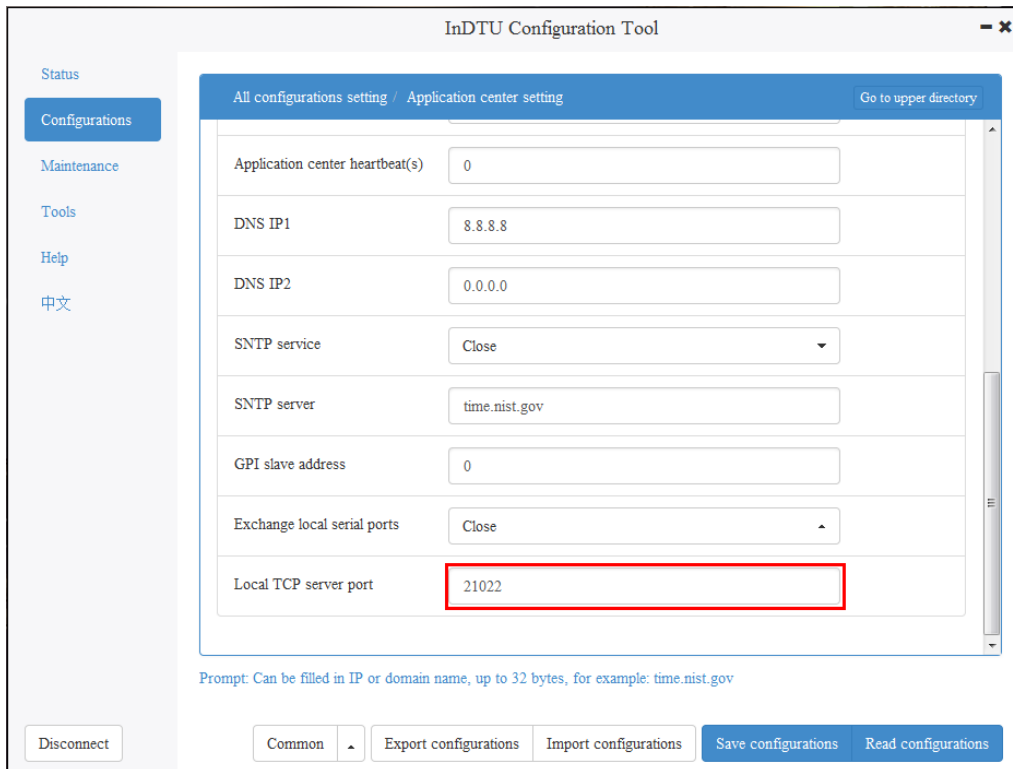

Figure 4-3-1 Setting the TCP server (1)

Step 3: Enter the APN provided by the SIM card operator and the network dial username/password, as shown in Figure 4-3-2.

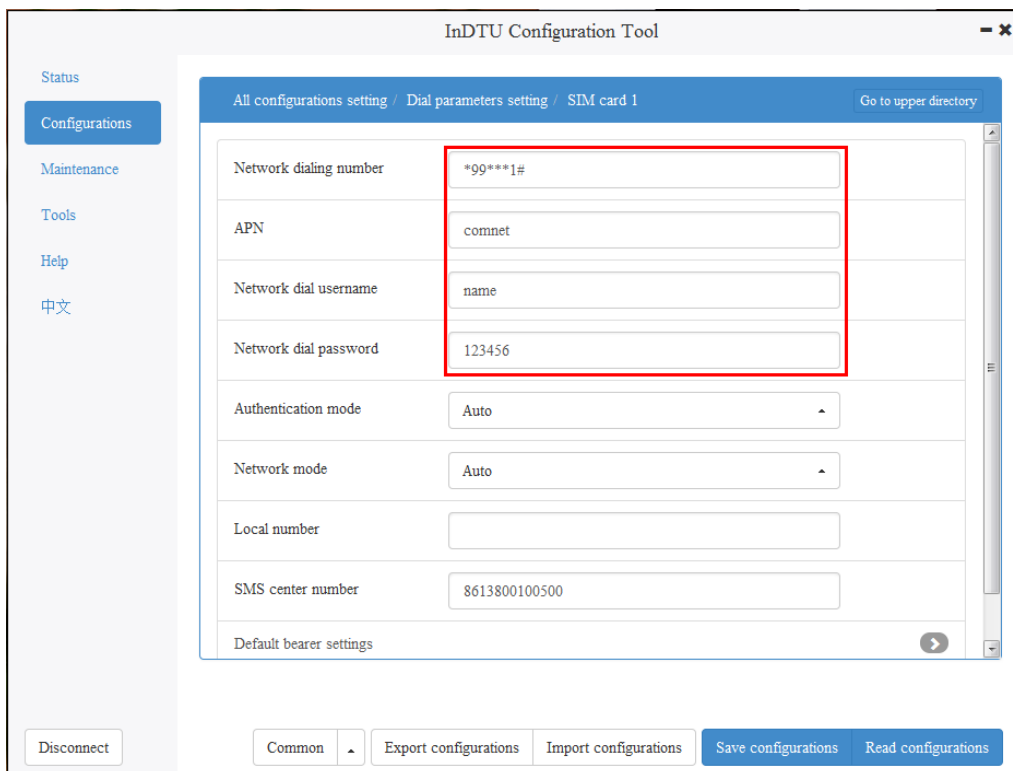

Figure 4-3-2 Setting the TCP server (2)

Step 4: Set the ICMP parameter to prevent the DTU from automatically restarting when detecting no network data in two hours. **Link maintenance function** must be set to **Close**, as shown in Figure 4-3-3.

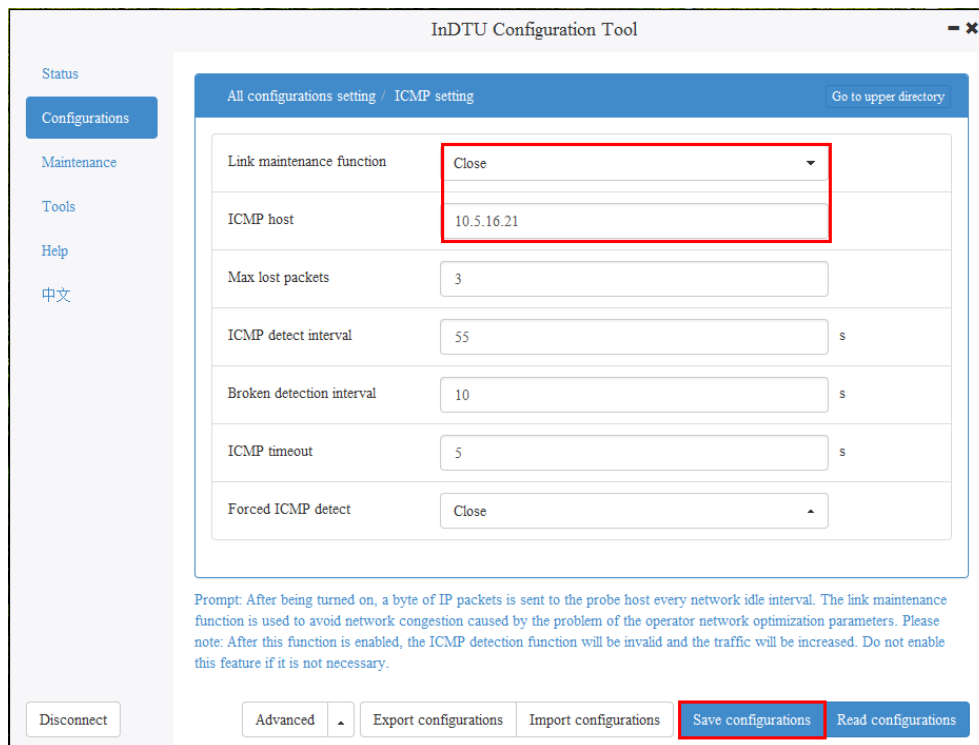

Figure 4-3-3 Setting the TCP server (3)

Step 5: **After setting the parameters, click Save configurations. The parameter settings take effect after a restart.**

Step 6: In InDTU3XX_STD_V1.5.4 and later versions, if a client is successfully connected to the DTU that acts as a TCP server, view the IP address and connection status of the client by using the configuration tool.

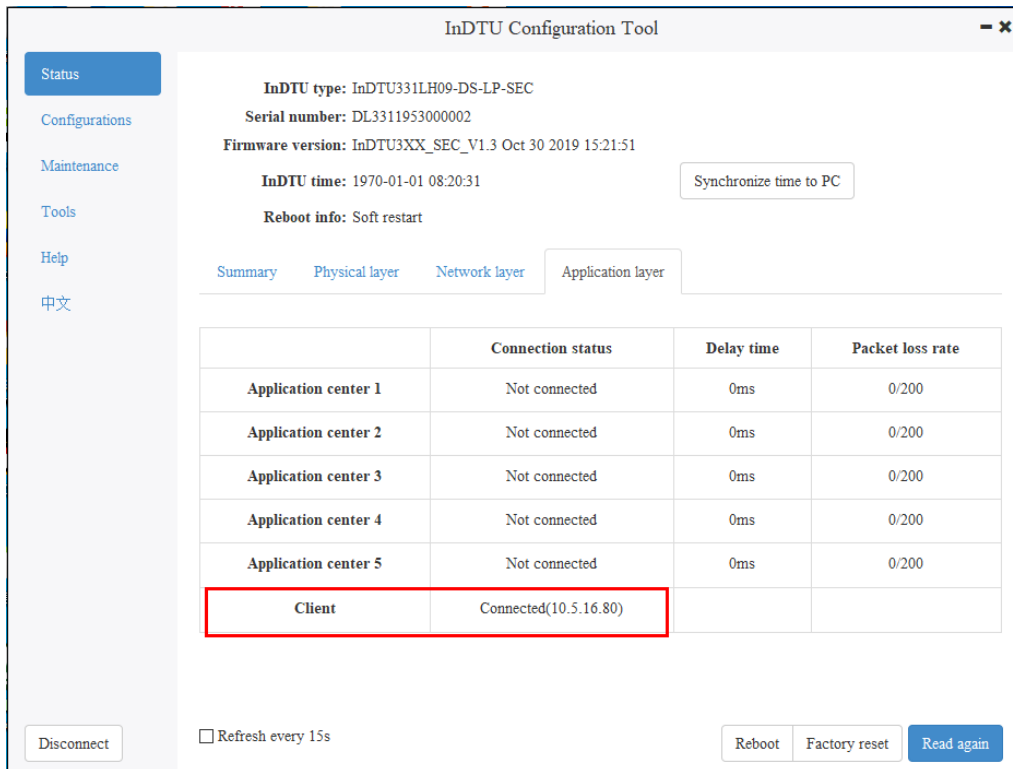

Figure 4-3-4 Client successfully connected

4.4 Modbus-Net-Bridge

Modbus-Net-Bridge is used for conversion between Modbus RTU and Modbus TCP. The Modbus TCP master station can access the Modbus RTU device connected to local serial port 1.

Step 1: Select **Modbus-Net-Bridge**.

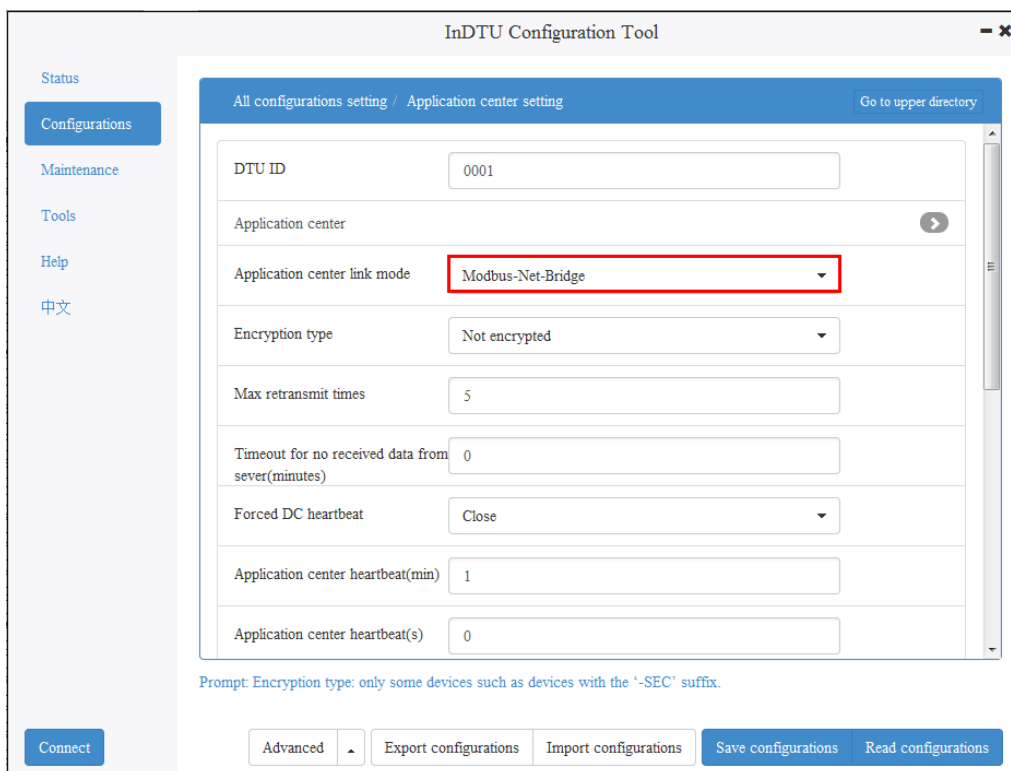

Figure 4-4-1 Modbus-Net-Bridge setting 1

Step 2: Enter the APN provided by the SIM card operator and the network dial username/password, as shown in Figure 4-4-2.

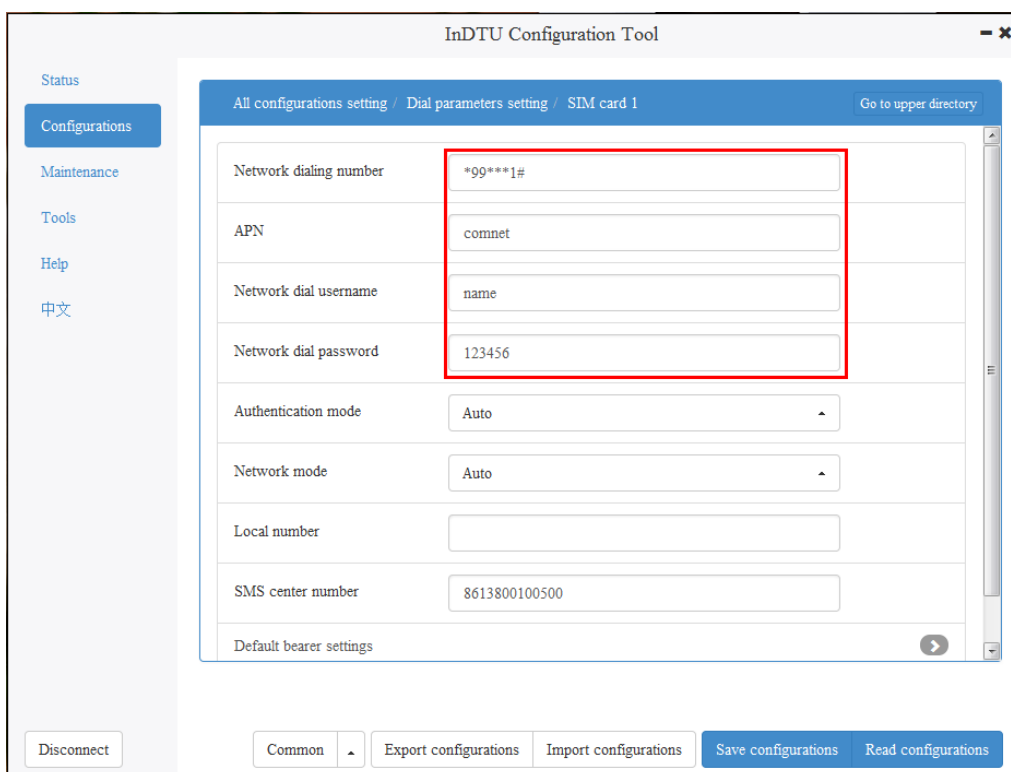

Figure 4-4-2 Modbus-Net-Bridge setting 2

Step 3: After setting the parameters, click **Save configurations. The parameter settings take effect after a restart.**

4.5 Multi-application Center

Step 1: Choose **Configurations > All Configurations setting > Application center setting > Application center**.

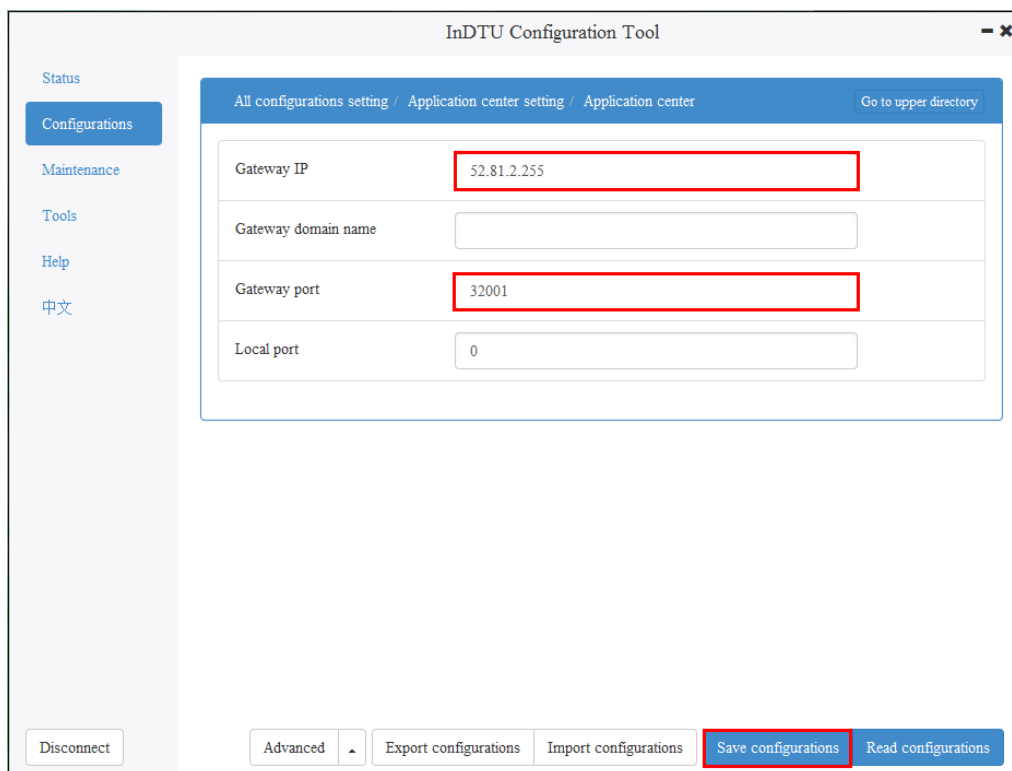

Figure 4-5-1 Setting Gateway IP

Step 2: Choose **Configurations > All Configurations setting > Multi application center setting > Extended application center 1** and set the extended gateway.

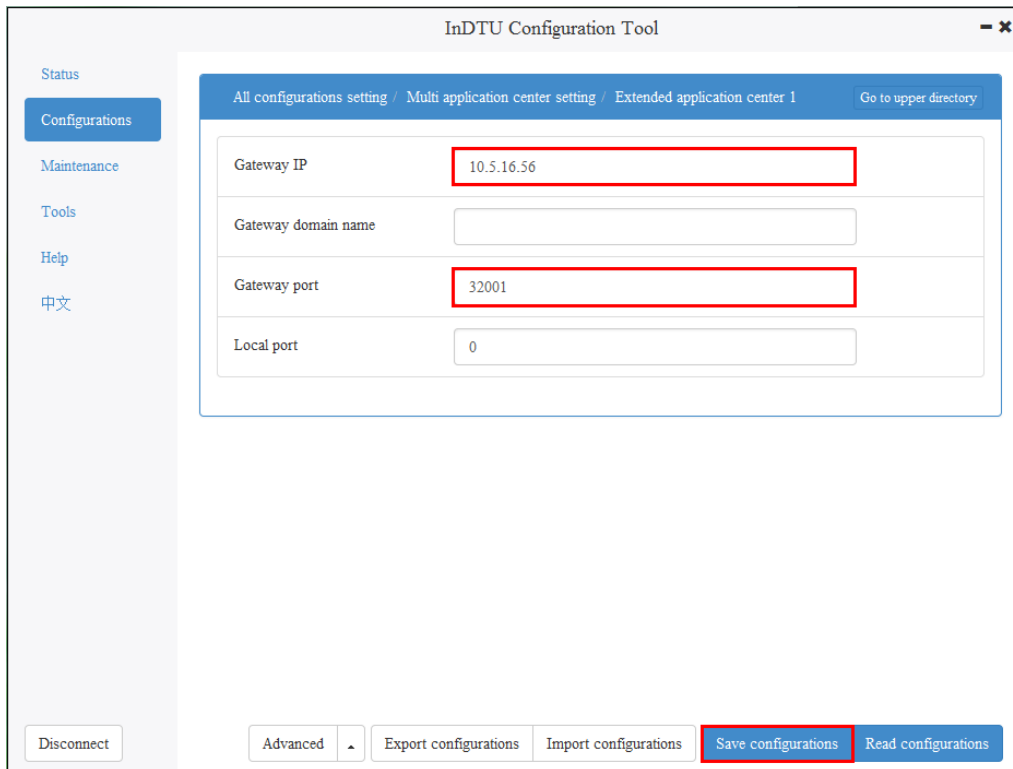

Figure 4-5-2 Setting an extended gateway

Step 3: Repeat steps 1 and 2 to **set extended application gateways in sequence**.

4.6 Connecting the DTU to the DM Cloud Platform

Select **SMS+IP**, access the DM address page, enter the address of the DM cloud platform, and click **Save configurations**.

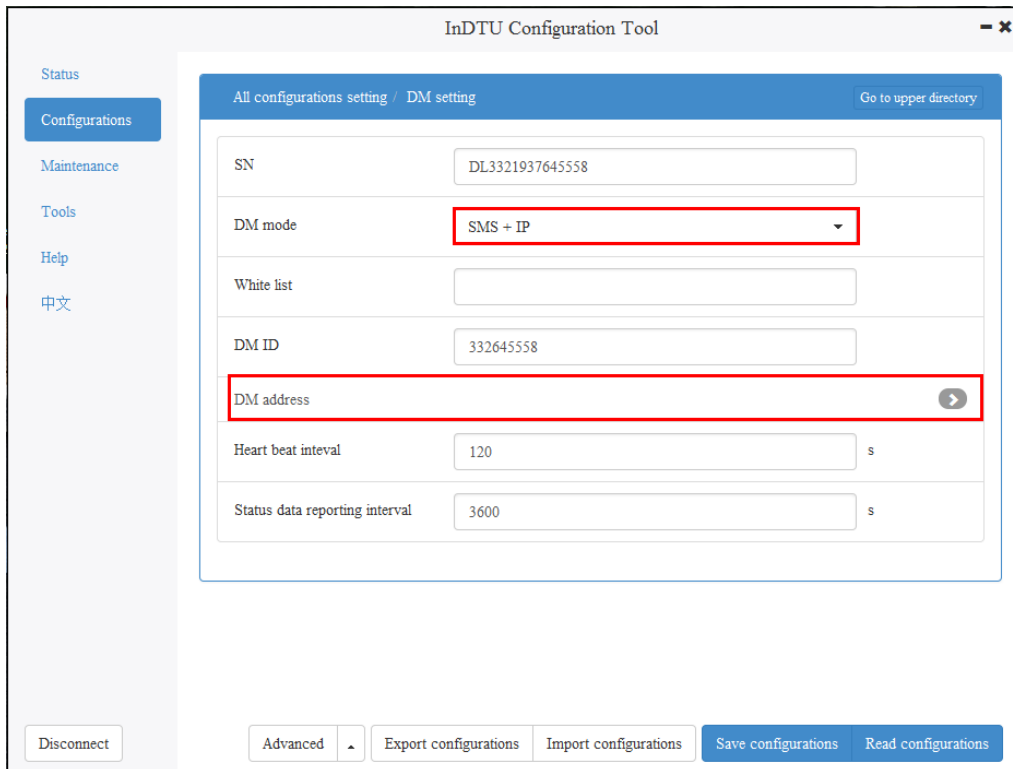

Figure 4-6-1 Connecting to the DM cloud platform (1)

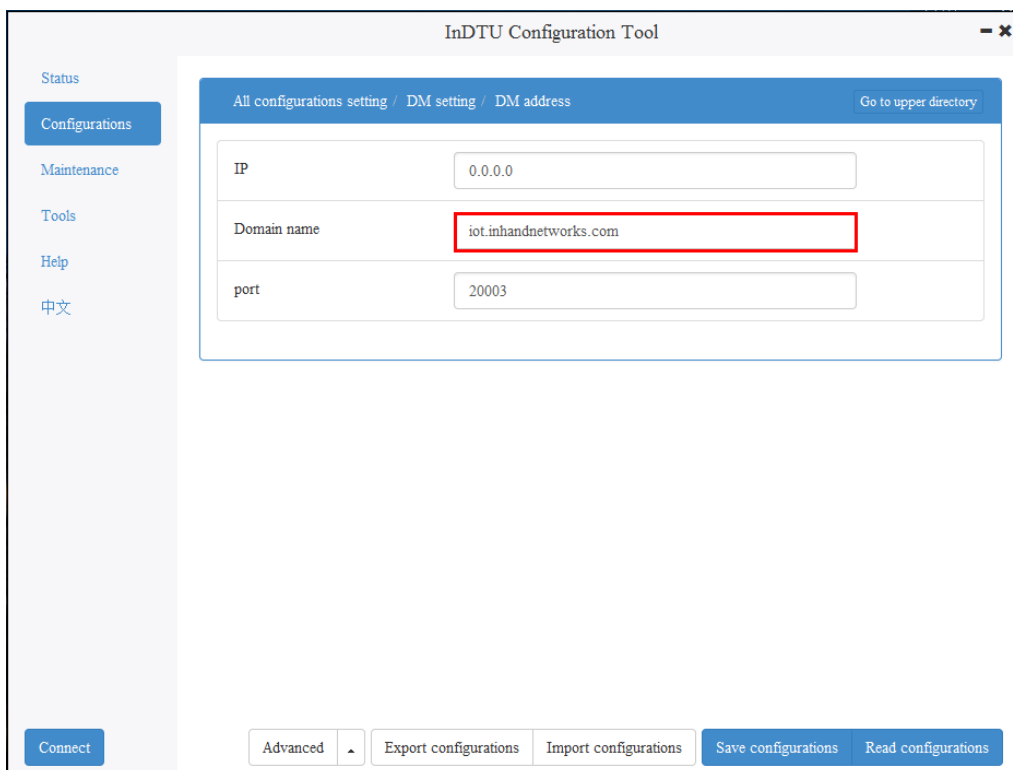

Figure 4-6-2 Connecting to the DM cloud platform (2)

4.7 Transmission Mode

Long connection: The InDTU communicates with the center uninterruptedly.

Short connection: The InDTU communicates with the center intermittently. Only **Short connection** needs to be activated.

Activation method:

Phone active: Dial the SIM card of the InDTU with your phone, wait 20s or longer, and log in the device to check the connection status. The device is successfully connected to the center.

Local data active: Send data to the InDTU via serial port 1 of the device for activation.

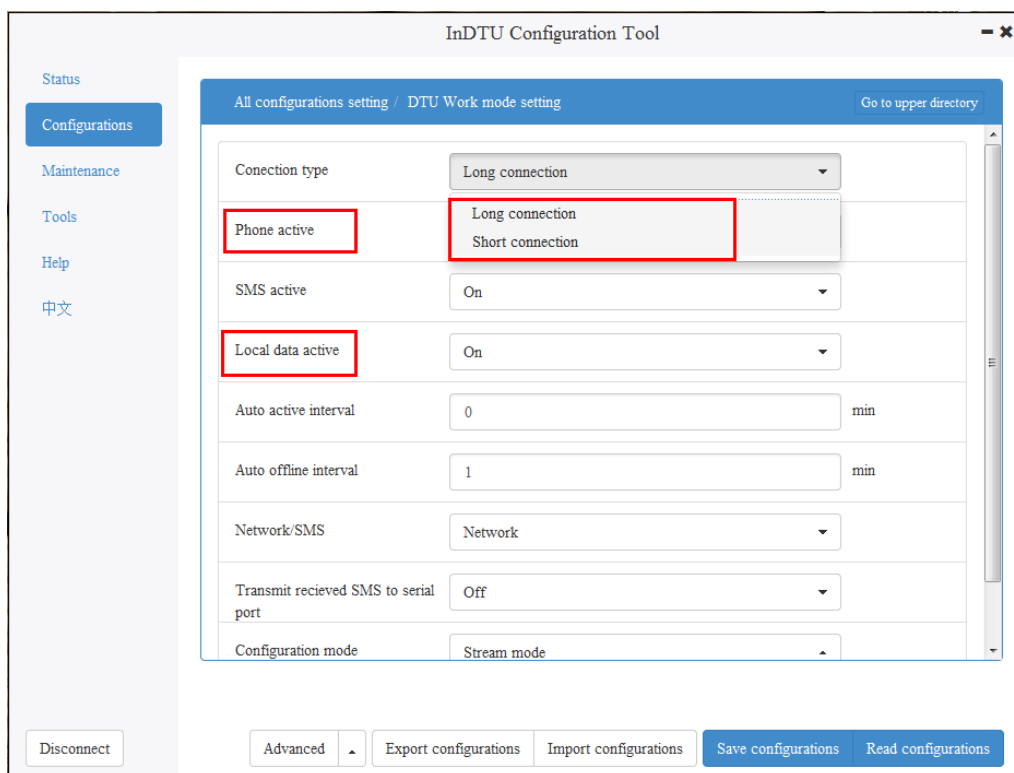

Figure 4-7-1 Selecting a connection type and an activation method

4.8 ICMP/Link Maintenance Function

ICMP host: used to detect whether the network is normal, as shown in Figure 4-8-1.

Link maintenance function: used to avoid network congestion caused by the problem of the operator network optimization parameters, as shown in Figure 4-8-2.

Note: The link maintenance function and ICMP detection function are mutually exclusive. When the link maintenance function is enabled, the ICMP detection function is unavailable.

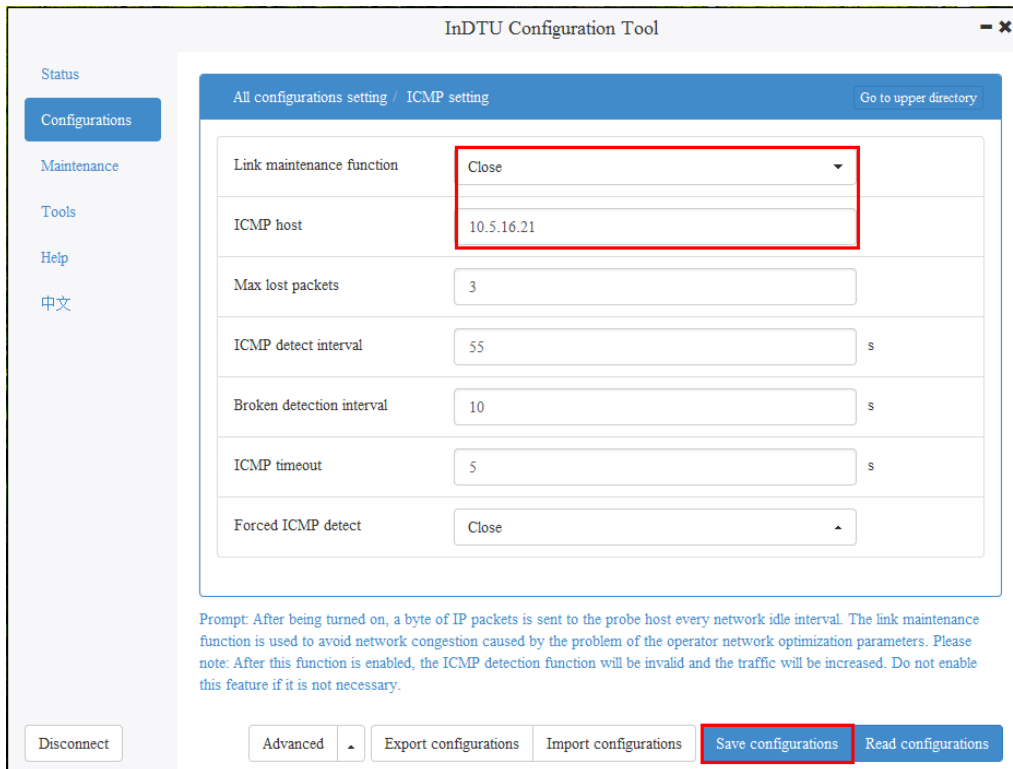

Figure 4-8-1 ICMP parameter setting

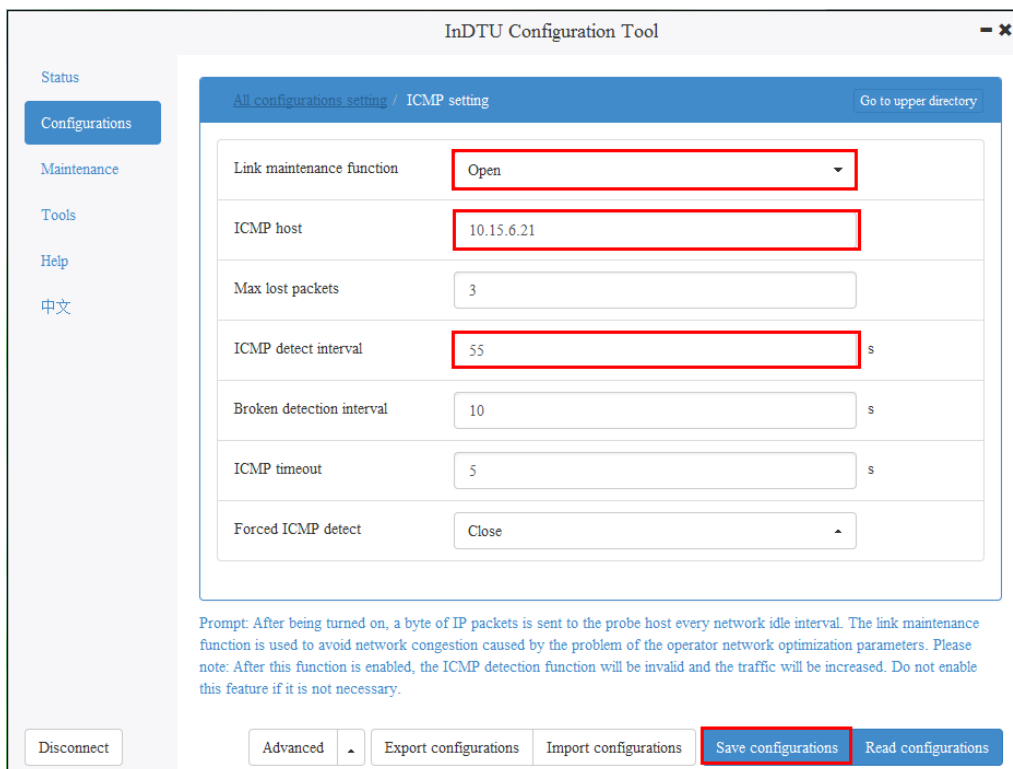

Figure 4-8-2 Link maintenance parameter setting

4.9 Dual-SIM Switching Function

Step 1: Choose **Configurations > All Configurations Setting > Dial parameters setting**, and set **Dual SIM mode** and **Switch card without connecting the center** to **Open**, as shown in Figure 4-9-1.

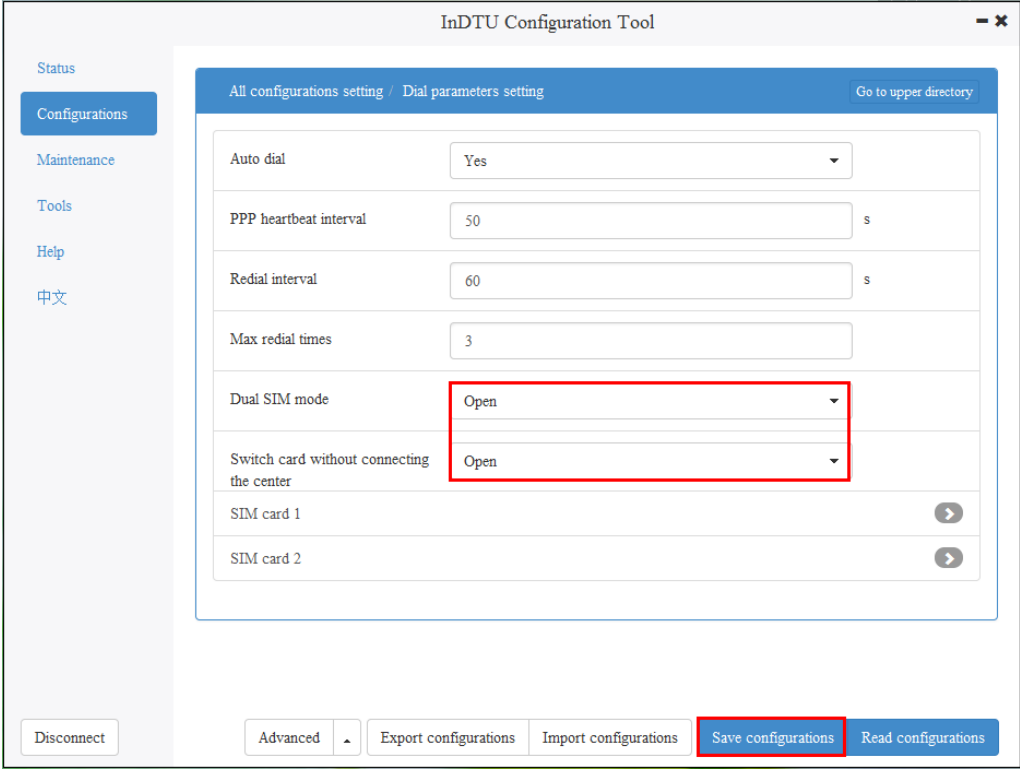

Figure 4-9-1 Dual-SIM switching setting 1

Step 2: Choose **Configurations > All Configurations Setting > Application center setting** and set **Application center link mode** to **TCP**, because **Switch card without connecting the center** is available only when **Application center link mode** is **TCP**, as shown in Figure 4-9-2.

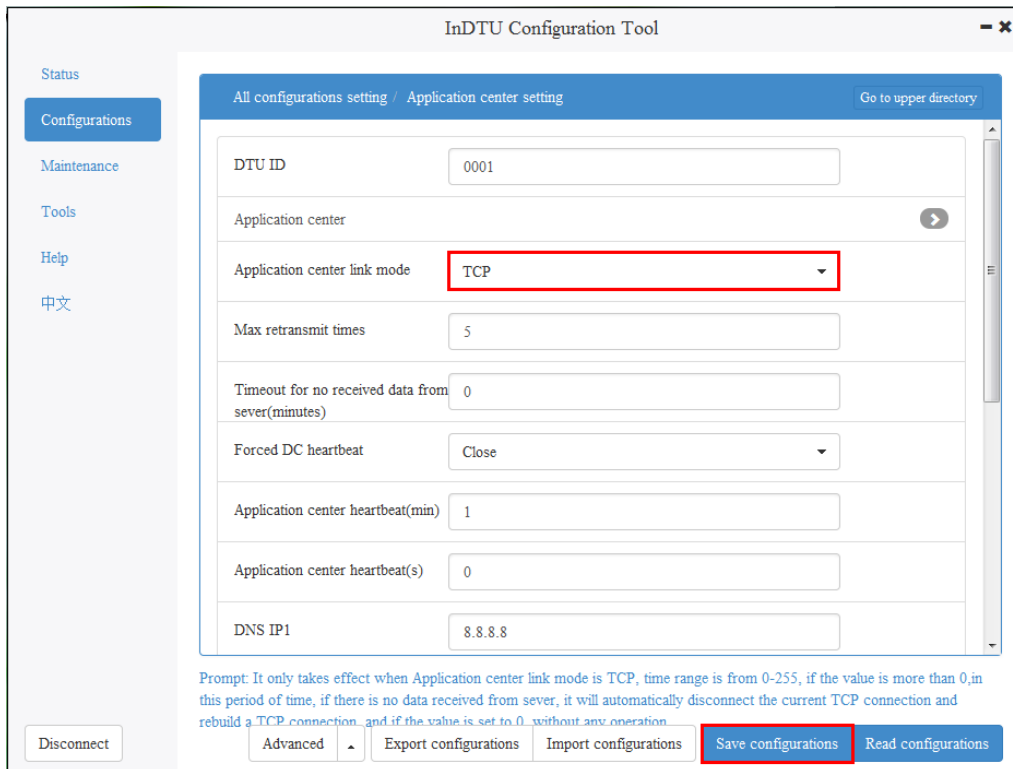

Figure 4-9-2 Dual-SIM switching setting 2

Step 3: Choose **Configurations > All Configurations Setting > Other setting** and set **Max login times** as required, as shown in Figure 4-9-3.

Example:

(1) Currently, one center is configured, and **Max login times** is set to **3**. When the number of failures to establish a connection to the center reaches 6, the SIM card is switched for redialing.

(2) Currently, one center is configured, and **Max login times** is **5** by default. When the number of failures to establish a connection to the center reaches 10, the SIM card is switched for redialing.

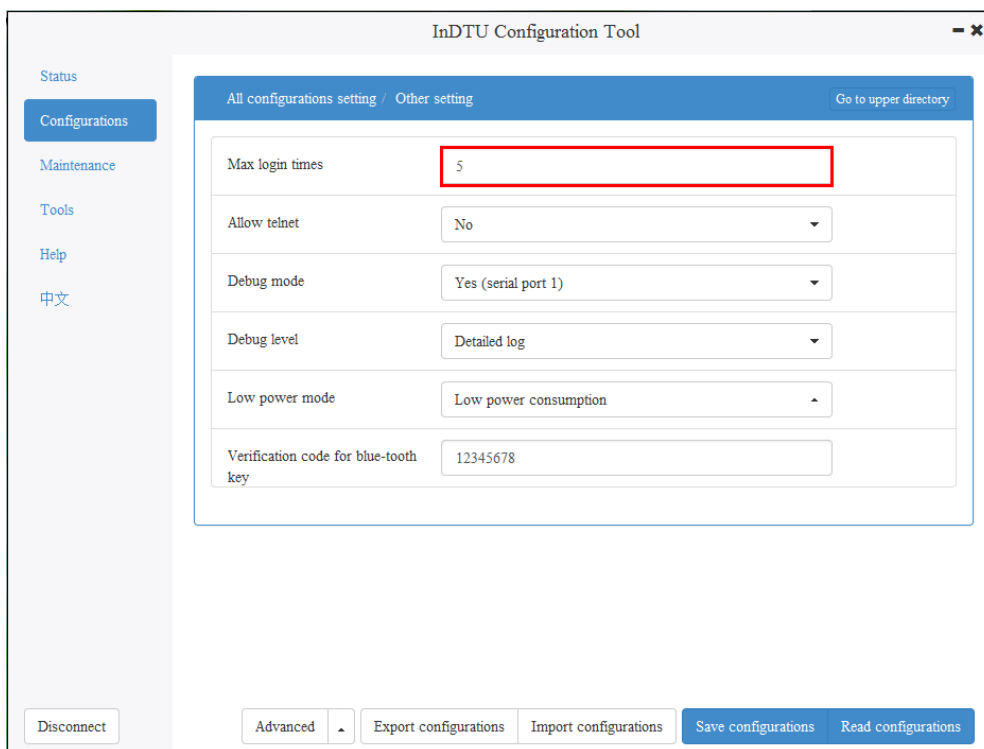

Figure 4-9-3 Dual-SIM switching setting 3

Step 4: If multiple centers need to be configured: choose **Configurations > All Configurations Setting > Multi application center setting > Extended application center 1** and complete the settings, as shown in Figure 4-9-4.

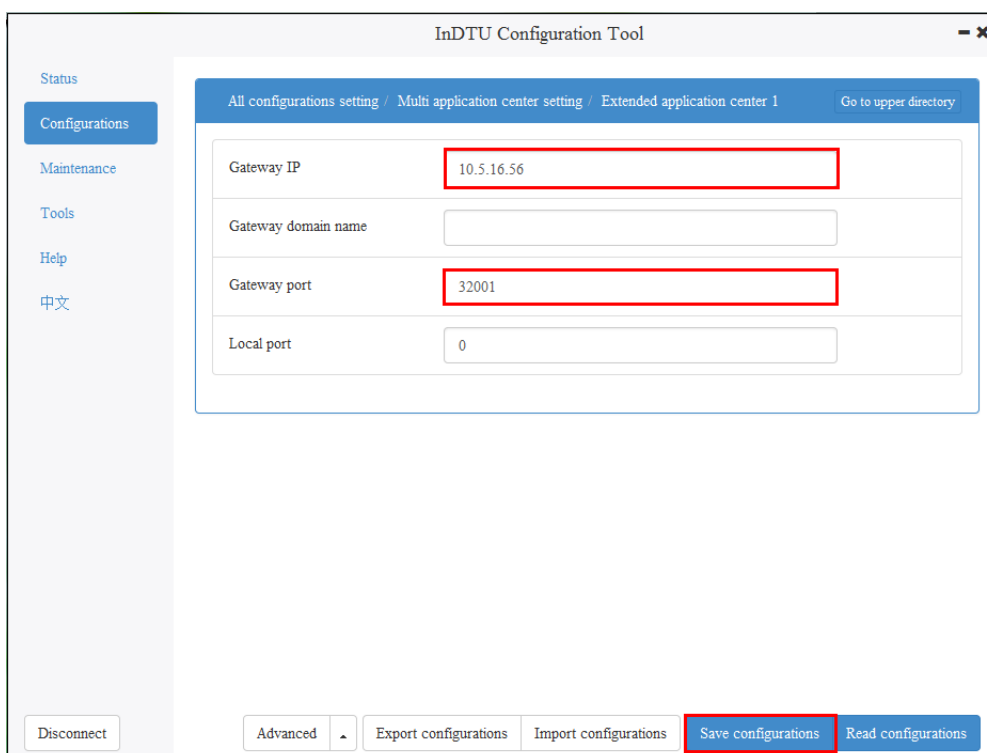

Figure 4-9-4 Dual-SIM switching setting 4

Example:

- (1) Currently, one center is configured, and **Max login times** is **5**. When the number of failures to establish a connection to the center reaches 10, the SIM card is switched for redialing.
- (2) Currently, two centers are configured, and **Max login times** is **5**. When the number of failures to establish a connection to the center reaches 20, the SIM card is switched for redialing.

Step 5: Choose **Configurations > All Configurations Setting > Multi-center mechanism setting** and set **Max reconnect interval** as required (the default value is **15s**), as shown in Figure 4-9-5.

Example:

When it is set to **15s**, the device attempts to establish a connection to the center every 15s until it is successfully connected to the center.

Step 6: After setting the parameters, click Save configurations. The parameter settings take effect after a restart.

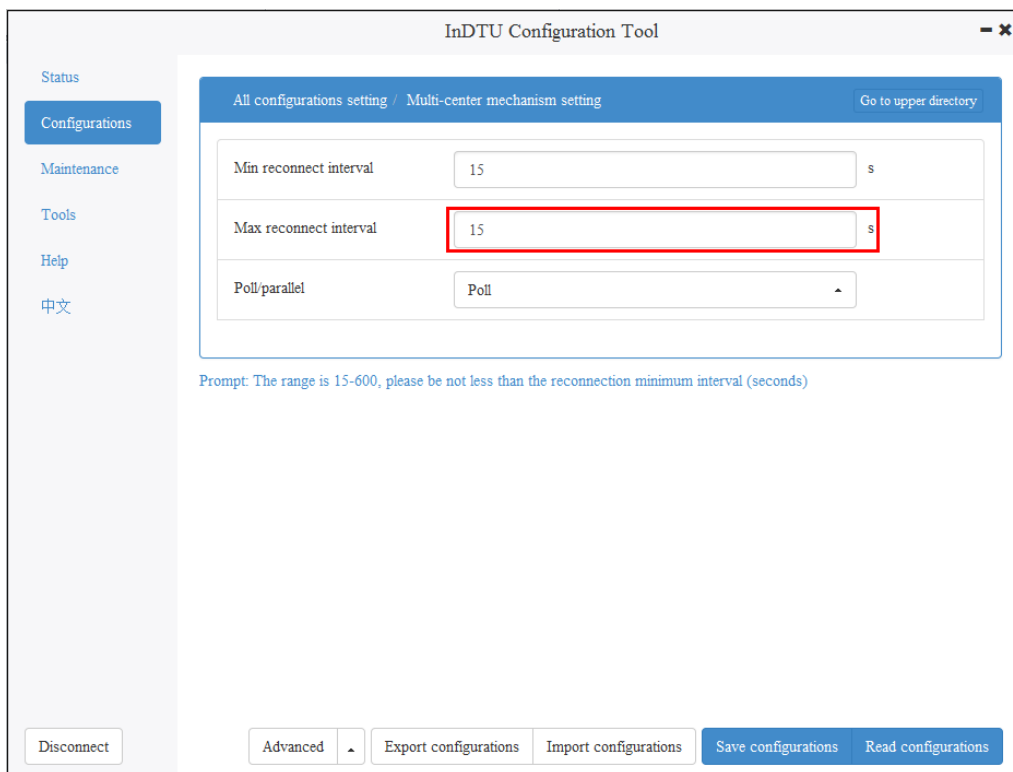

Figure 4-9-5 Dual-SIM switching setting 5



Note:

The SIM card is also switched in the following cases:

- (1) The number of lost ICMP packets exceeds the maximum value.
 - (2) No data service is available due to insufficient tariffs or incorrect APN settings.
 - (3) PAP/CHAP authentication fails (usually on private networks).
 - (4) The SIM card in the SIM 1 slot is faulty (for example, the SIM card is not detected).
 - (5) The signal strength is low (CSQ < 8), insufficient for data communication.
 - (6) Network registration fails.
 - (7) Network attaching fails.
 - (8) Dialing for data services fails (an ATD error occurs).
-

4.10 Maintenance

4.10.1 View Real-Time/ History Logs

Run the **InDTU Configuration Tool** and log into the device via serial port 2 of the DTU.

Select the "Advance mode>Configurations>Other " to configure the Debug Level and Debug mode as shown below.

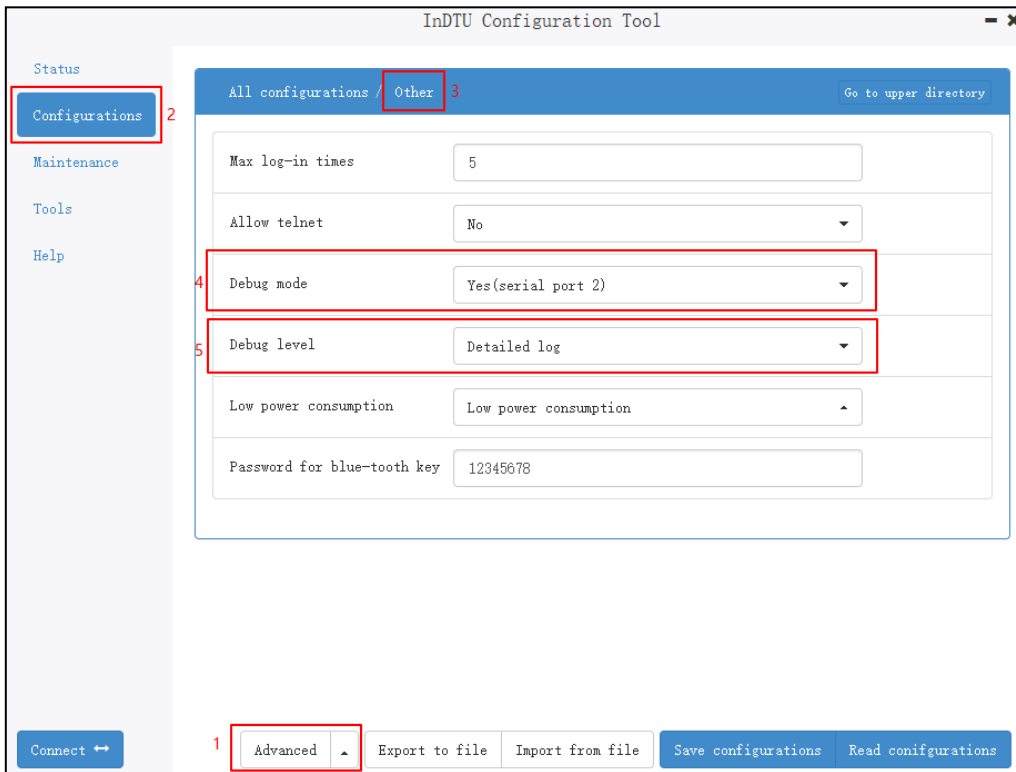

Figure 4-10-1 the configure about debug mode

Click "Maintenance > Real-time log/ History log". To display logs, click "Start reading". Wait for several seconds, and the logs are displayed. To stop updating the logs, click "Stop reading". To delete all displayed logs, click "Clear Screen". To export displayed logs, click "Export log", as shown in Figure 4-10-2/4-10-3/4-10-4.

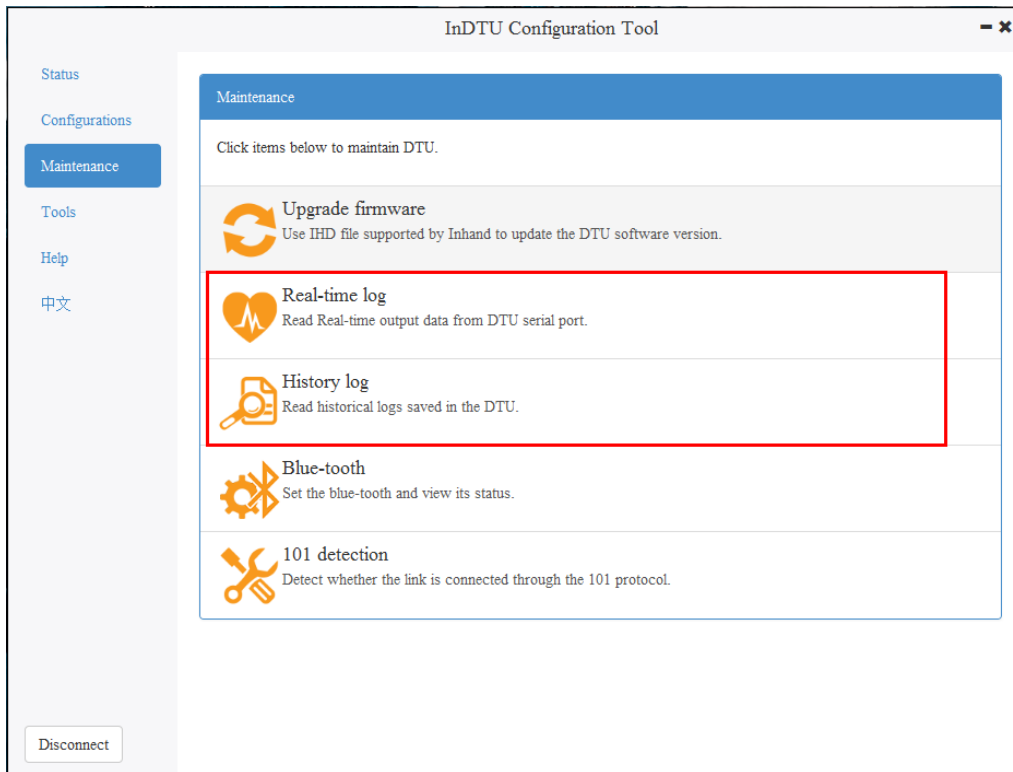

Figure4-10-2 Viewing real-time logs

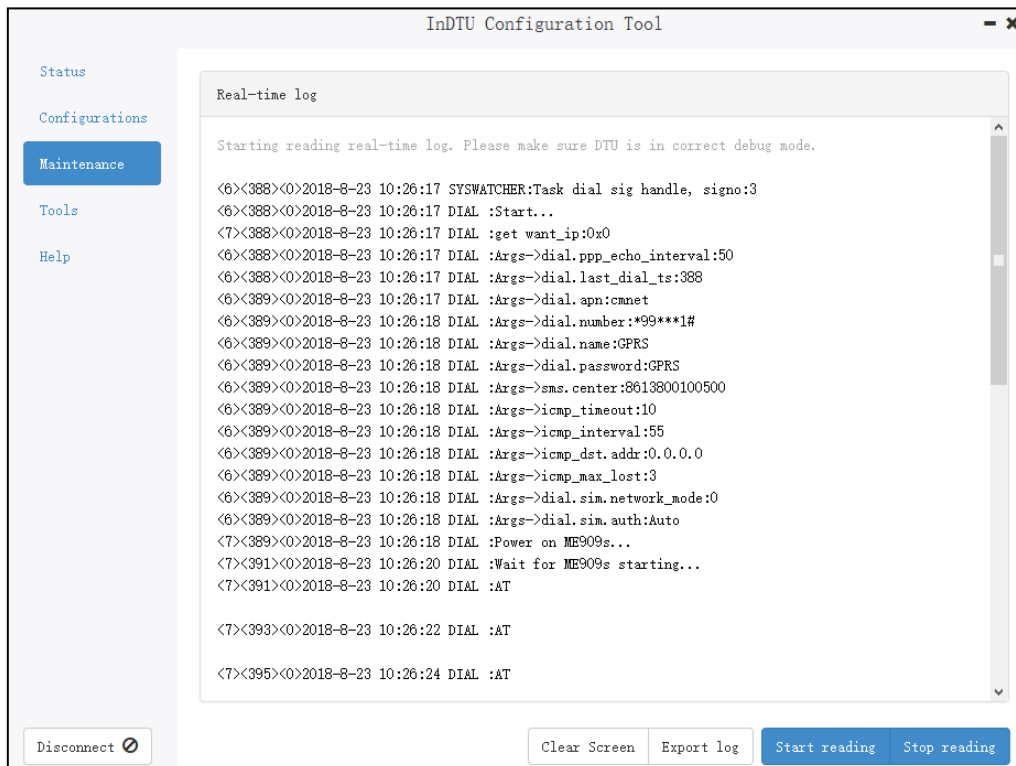

Figure4-10-3 Viewing real-time logs

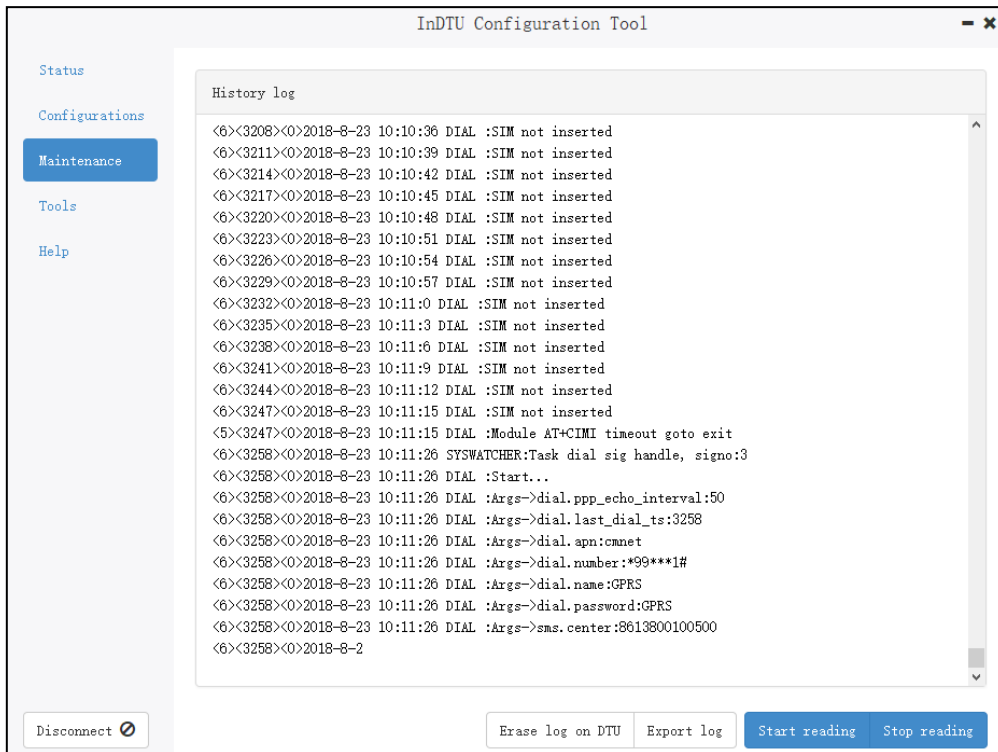

Figure4-10-4 Viewing History logs

4.10.2 101 Detection

Prerequisite: The DTU is connected to the master station that supports the 101 balanced protocol.

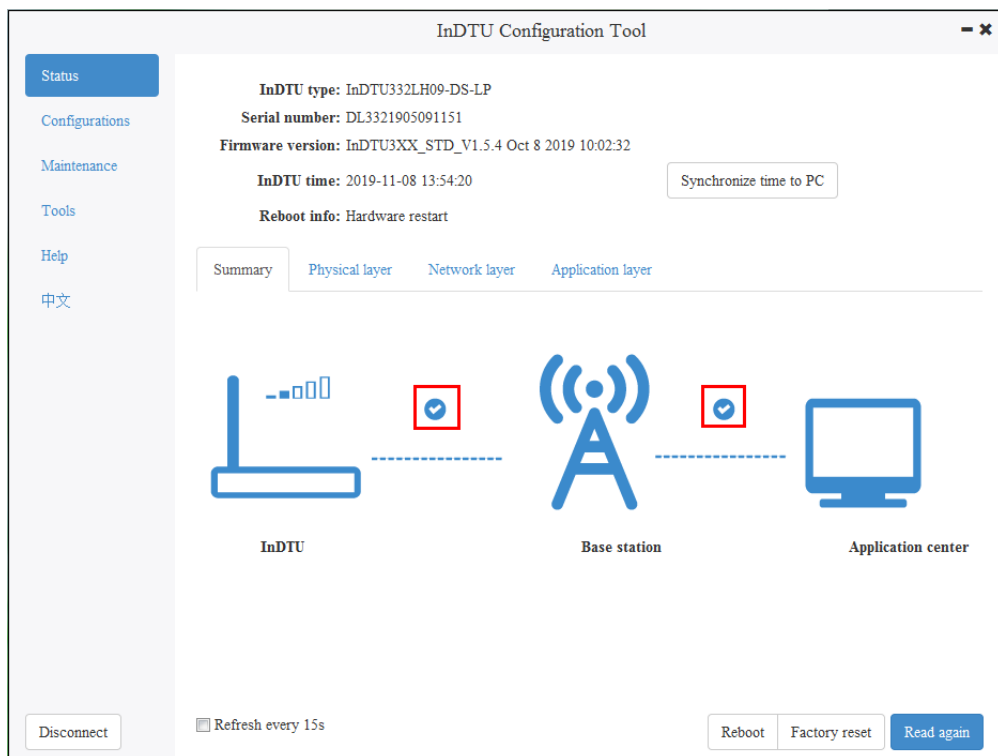

Figure 4-10-5 Connected state

Choose **Maintenance > 101 detection** to start detection. The "Detection success" message is displayed after detection is completed.

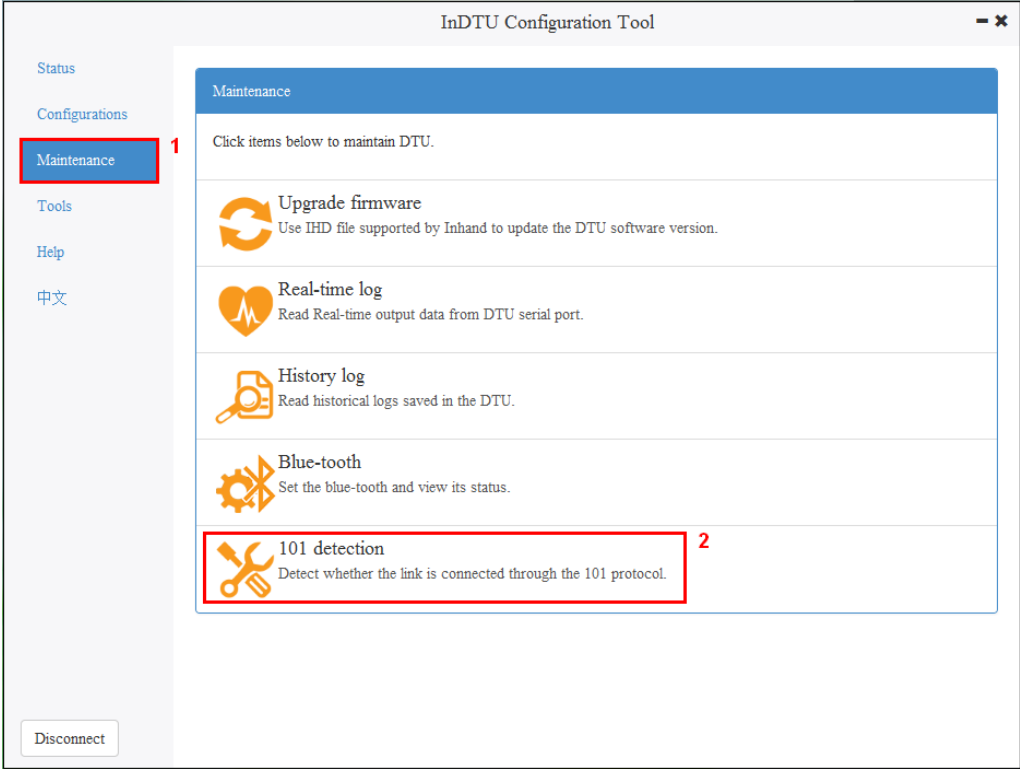

Figure 4-10-6 101 detection (1)

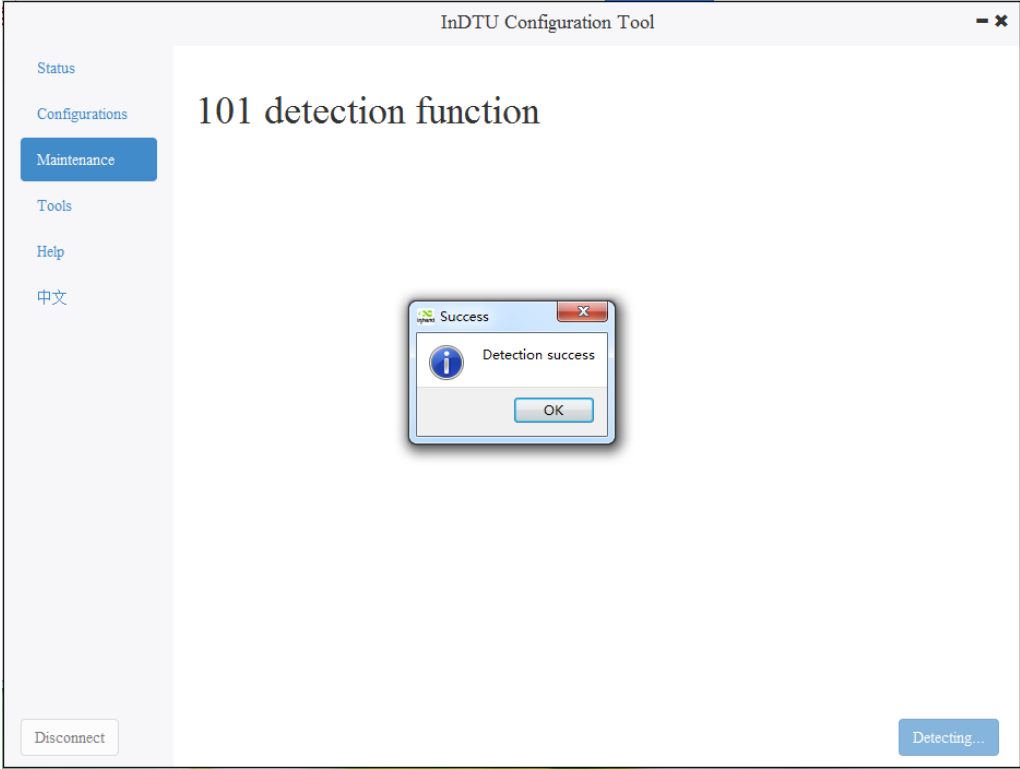
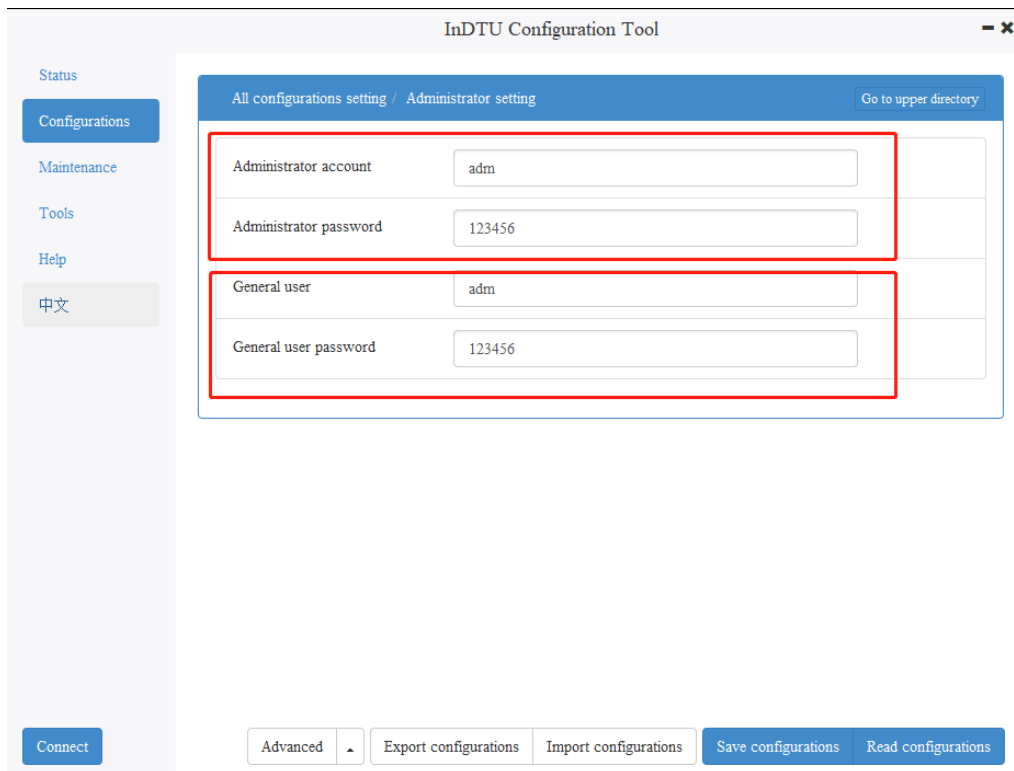

Figure 4-10-7 101 detection (2)

4.11 Other Functions

4.11.1 Login Settings for the Administrator

The DTU provides multi-level management for administrators and general users. The accounts and passwords must be set at the same time.



The screenshot displays the 'InDTU Configuration Tool' window. On the left is a sidebar with menu items: Status, Configurations (highlighted), Maintenance, Tools, Help, and 中文. The main content area is titled 'All configurations setting / Administrator setting' and includes a 'Go to upper directory' link. It contains two sections, each enclosed in a red box. The first section is for 'Administrator' settings, with 'Administrator account' set to 'adm' and 'Administrator password' set to '123456'. The second section is for 'General user' settings, with 'General user' set to 'adm' and 'General user password' set to '123456'. At the bottom of the window, there is a 'Connect' button, a dropdown menu set to 'Advanced', and buttons for 'Export configurations', 'Import configurations', 'Save configurations', and 'Read configurations'.

Figure 4-11-1 Setting the account and password of an administrator or a general user

4.11.2 Import/Export Configuration

DTU supports below 2 types configuration file:

The .ini or .cfg file is a plain-text file with comments and easy to read/view.

The .ini or .cfg file is a binary file with a smaller file size.

Step:1 After establishing a connection with the DTU through the configuration tool and logging in. Click the <Export to File> or <Import from File> button to export or import the configuration file, as shown in Figure 4-11-2.

Step:2 After importing the configuration file, click **Save configurations**. The parameter settings take effect after a restart.

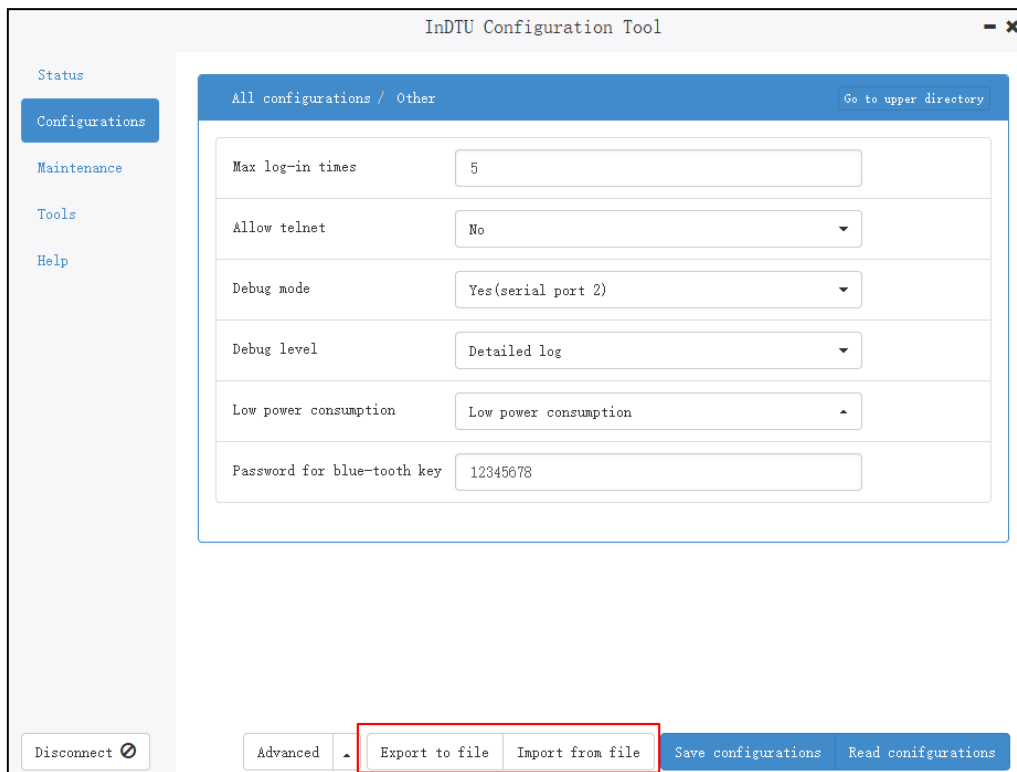

Figure 4-11-2 Importing/Exporting configuration

4.11.3 Upgrade Device

Choose "Maintenance > Upgrade firmware".

- (1) Select a new DTU firmware to upload, as shown in Figure 3-4;
- (2) Click the "Upgrade" button to start the upgrade, and its progress bar is displayed, as shown in Figure 3-5;
- (3) Popup a message box to remind you restart the device, as shown in Figure 3-6;
- (4) The DTU device will establish a connection with DTUTool again, log into the device, and check the firmware version currently in effect in the status bar to confirm whether the upgrade is successful, as shown in Figure 4-11-3.

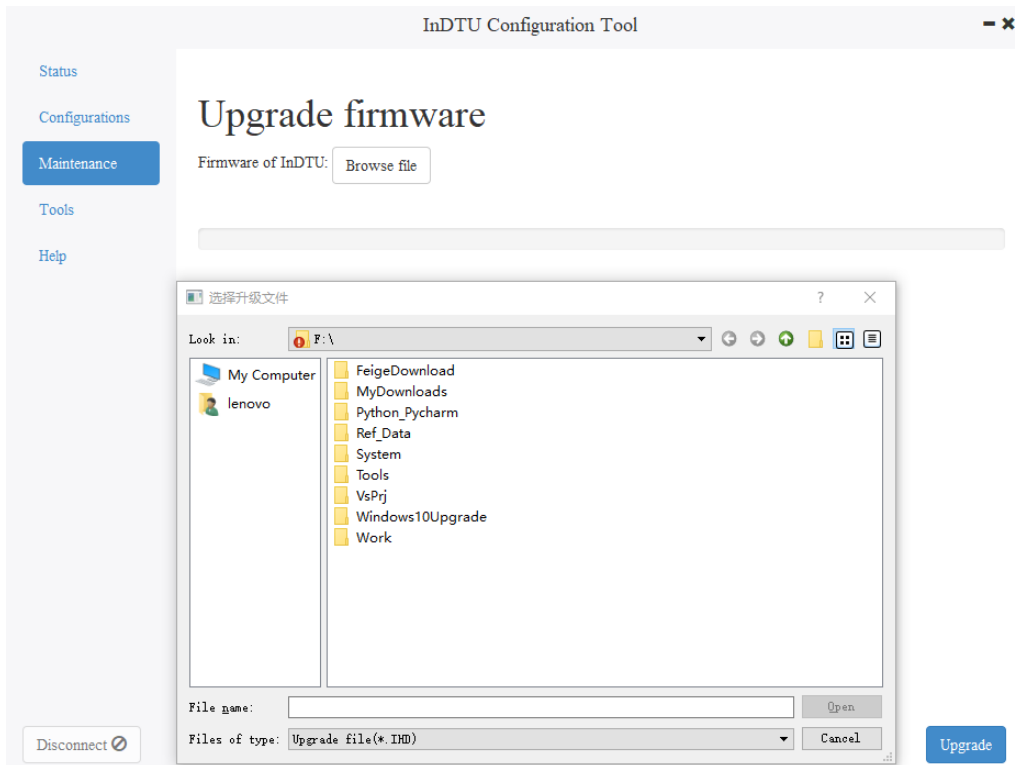

Figure4-11-3 select firmware

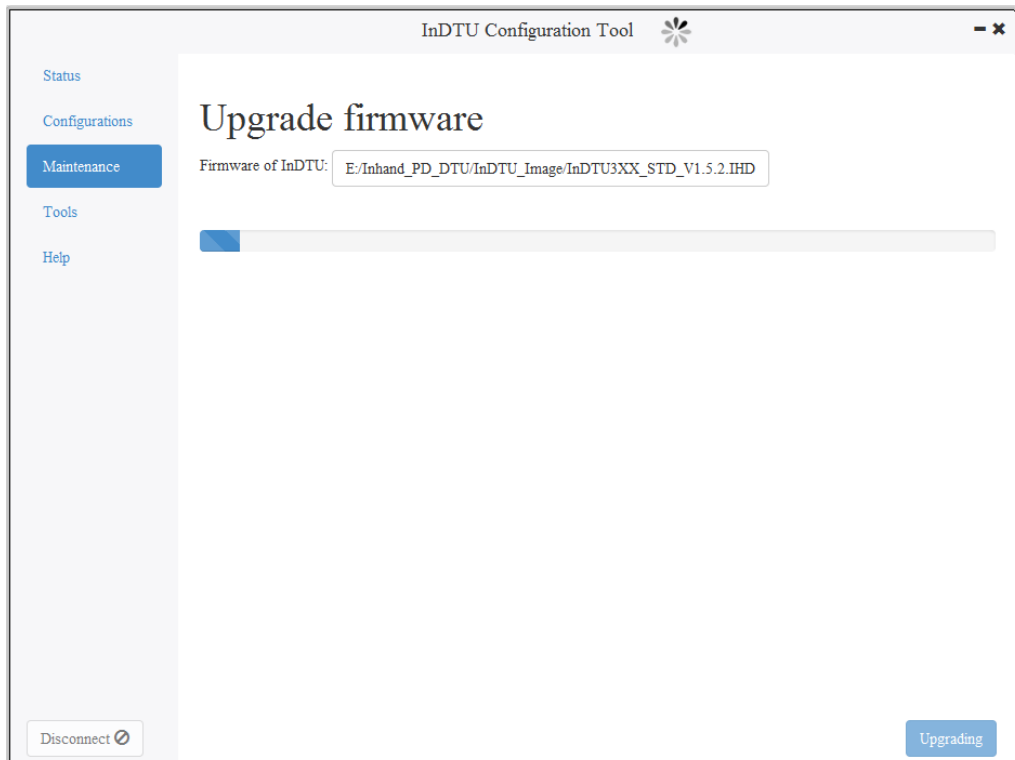

Figure4-11-4 upgrade firmware

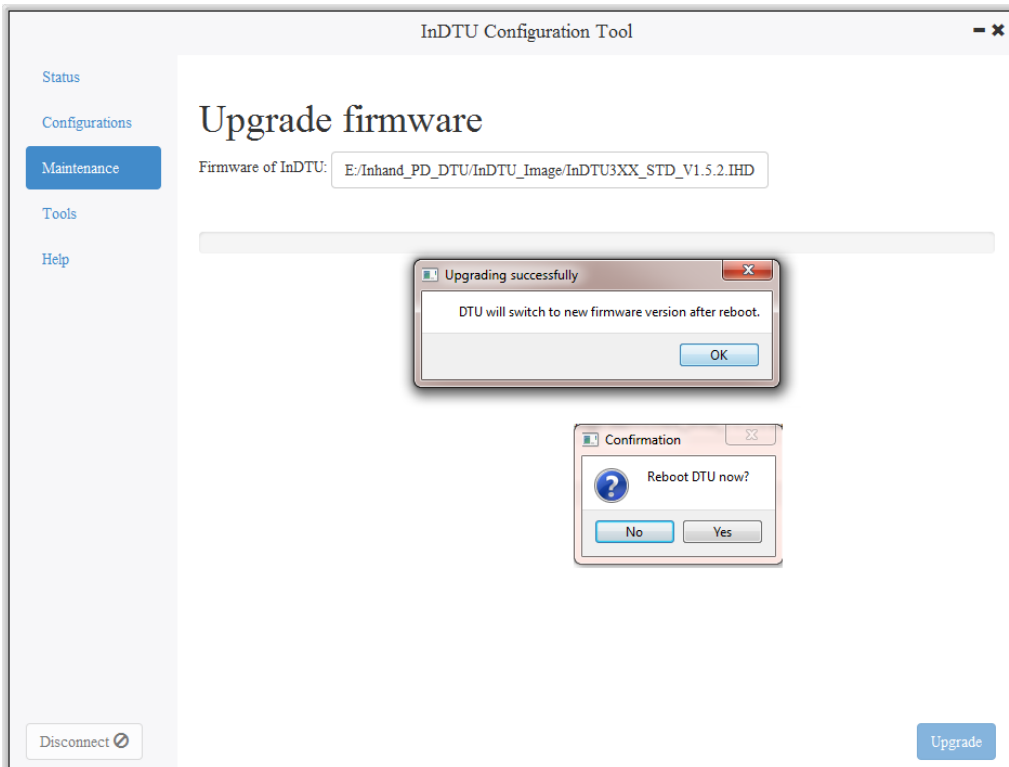

Figure4-11-4 popup after upgrade

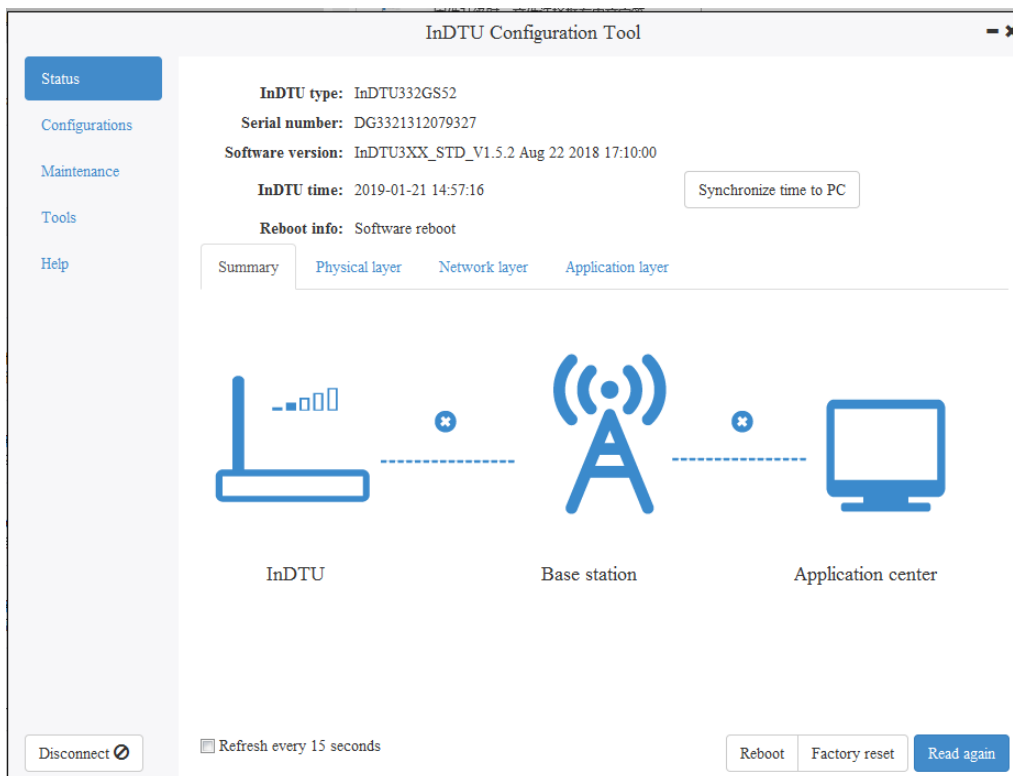

Figure4-11-5 confirm the upgrade result

4.11.4 Power Mode

Choose **Configurations > All configurations setting > Other setting** and select a power mode for the DTU, as shown in Figure 4-11-6.

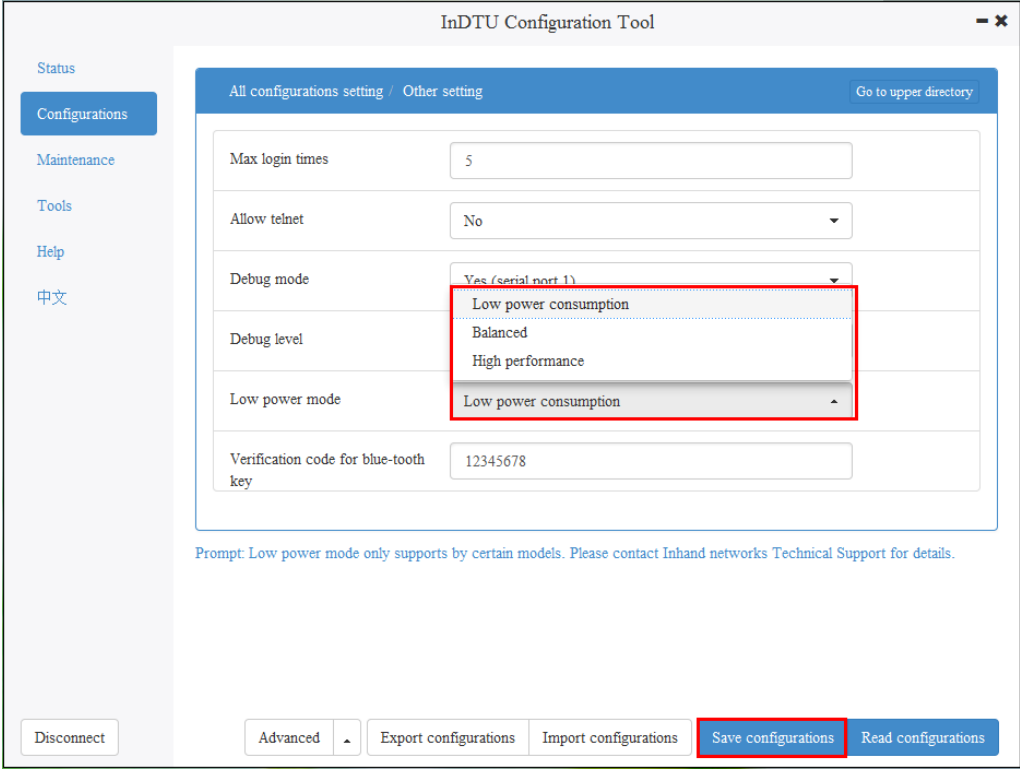

Figure 4-11-6 Selecting a power mode

4.11.5 Restoring Factory Settings

Connect the device and click **Factory reset > Confirm** to restore factory settings.

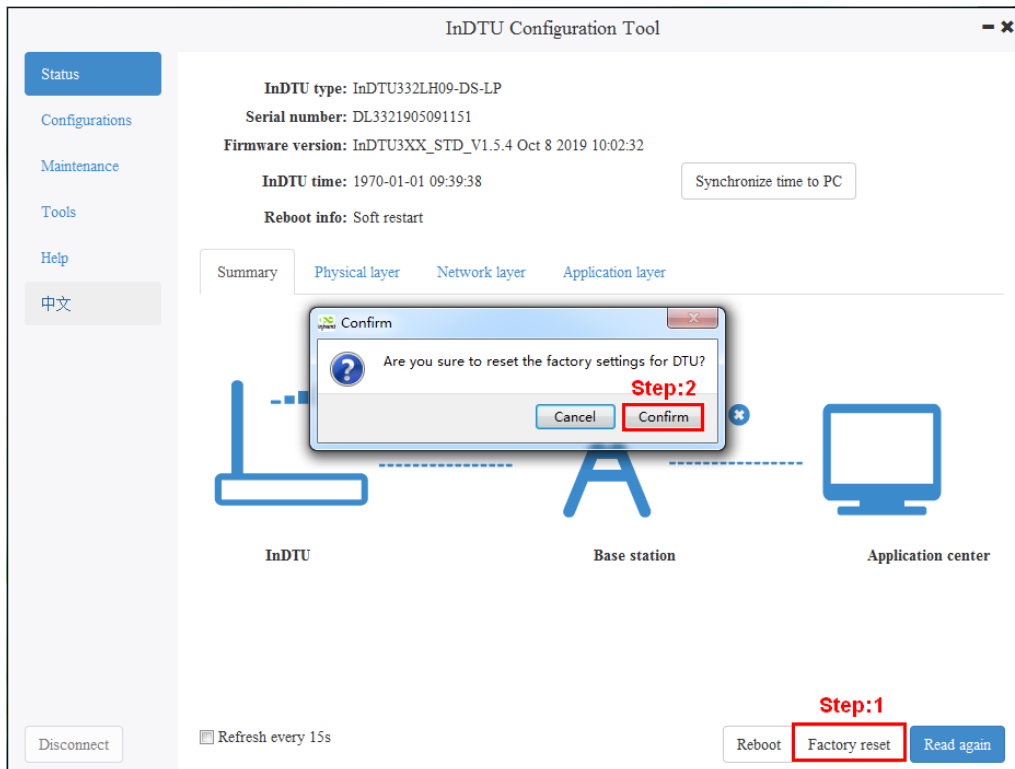

Figure 4-11-6 Restoring factory settings

4.11.6 SNTP Time Synchronization

Step 1: Choose **Configurations > All configurations setting > Application center setting** and enable the SNTP service to synchronize the time on the device with the current time. When the default SNTP server address is unavailable, enter the address that supports time synchronization.

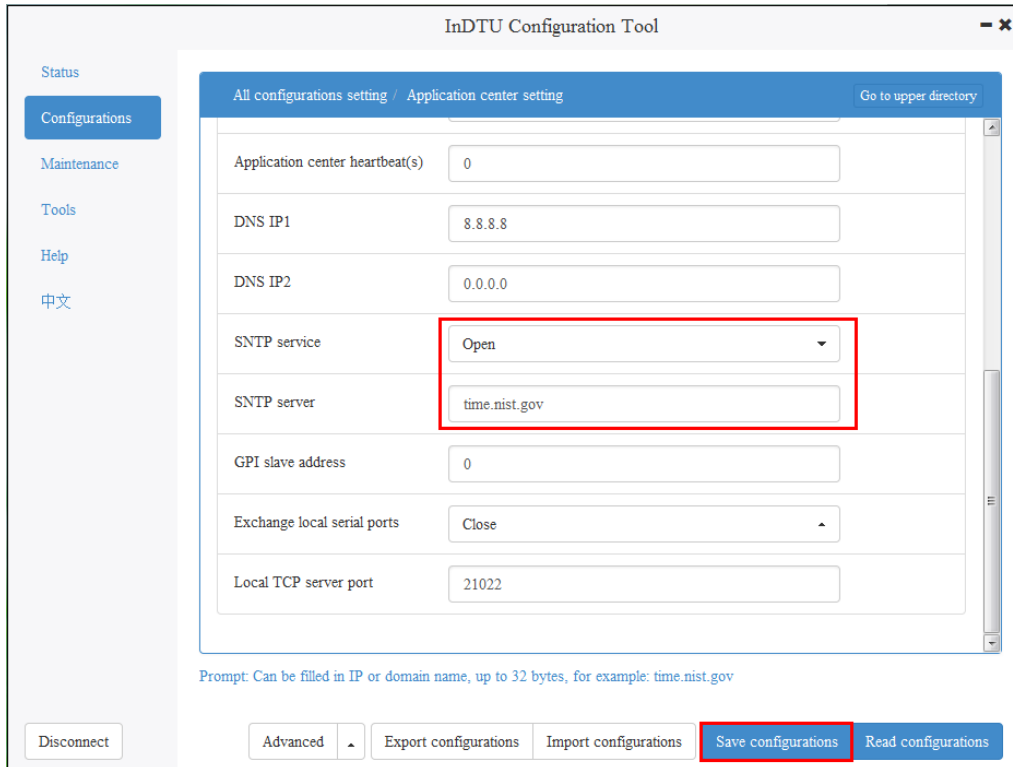

Figure 4-11-7 Enabling SNTP time synchronization

4.11.7 Short Message Sending/Receiving

Each English short message to be sent can contain up to 160 English characters. A long message is sent if there are more than 160 English characters. The long message is divided into several short messages, each of which contains less than 160 English characters. Sending is based on the long message protocol. When sending English short messages to the DTU, the user device encapsulates the ASCII value of the English characters in the TLV of the short message content.

For example, the short message content to be sent is "hello0123456!".

Step 1: Encapsulate the destination phone number, short message content, and short message format into an SMS command according to the IHDMP protocol. For example, "hello0123456!" and the destination phone number are encapsulated into a hexadecimal instruction according to the IHDMP protocol:

55AA55AA1300258180000B313538313836323330313081810001028182000D68656C6C6F3031323334353621A25F. (For more information, see the IHDMP protocol documentation.)

Step 2: Download a serial port tool by using the browser, connect to serial port 1 of the InDTU, set the sending/receiving format to HEX, and copy the compiled instruction to the serial port tool, as shown in Figure 4-11-8. (UartAssist is used here.)

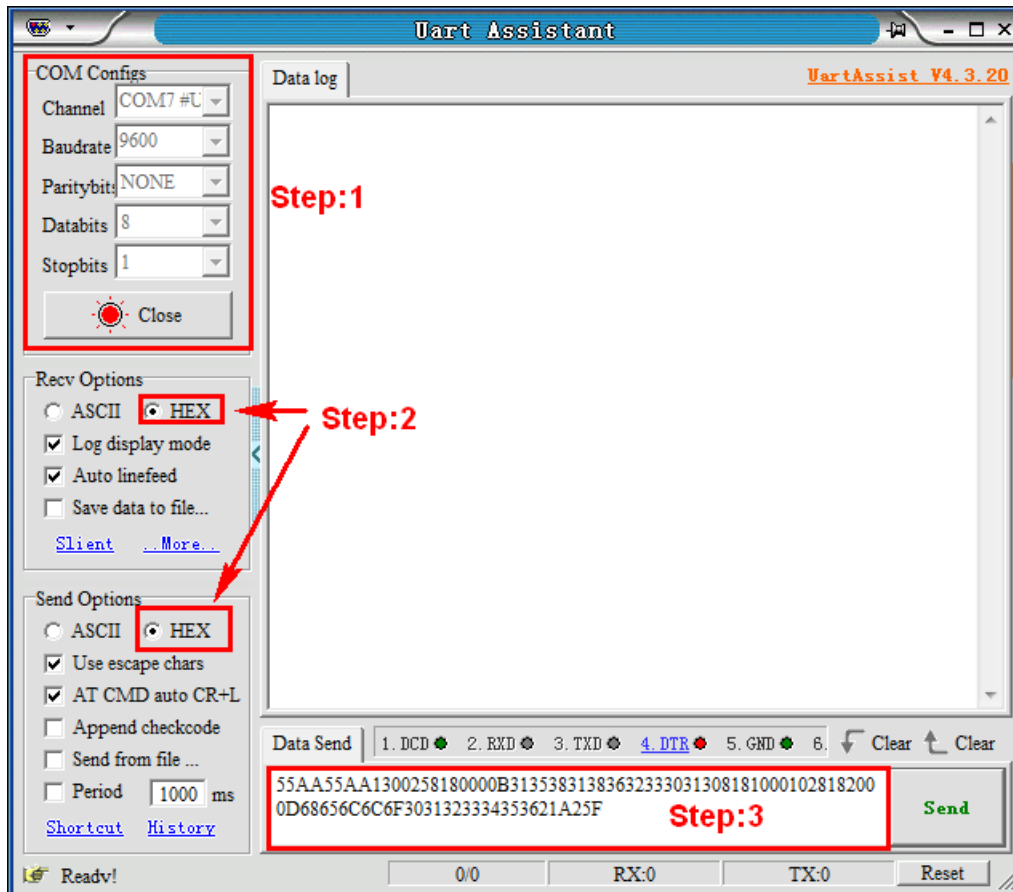

Figure 4-11-8 SMS application example 1

Step 3: Click **Send**. After the short message is sent, serial port 1 receives two acknowledgment instructions, among which the second instruction indicates whether the sending succeeds (01: succeeded; 00: failed), as shown in Figure 4-11-9.

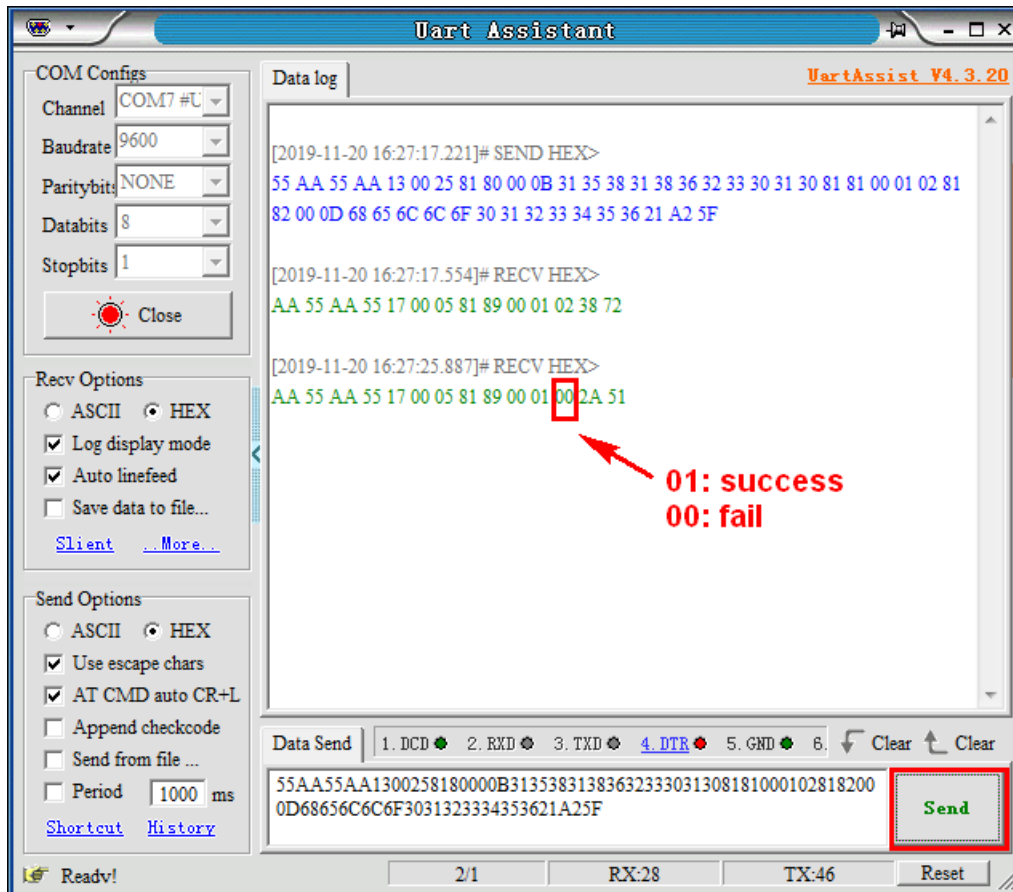

Figure 4-11-9 Failure to send a short message

Step 4: Check whether the phone receives a message. The phone receives "hello0123456!" if the sending succeeds and receives no message if the sending fails.

5 FAQ

1) DTU332/DTU324 reboots frequently.

Troubleshooting procedure:

1. Check whether the device can go online by dialing.
2. Check whether the UIM/SIM/USIM card is correctly inserted into the DTU.
3. Check whether the UIM/SIM/USIM card is suspended for arrears, or damaged.
4. Check whether the dialing parameters (such as dial number, access point parameter, account, and password) are correct.
5. Check whether wireless signal strength is lower than 20. Move the DTU to a place with stronger signal strength and power on it to retry.
6. Check whether the power supply to the DTU is normal.

2) DTU332/DTU324 is powered on, but power indicator is off.

Troubleshooting procedure:

1. Check whether the DTU is securely connected to the power converter.
2. Check that the 100 V AC to 240 V AC power supply can be provided.
3. Check whether the power converter of DTU can output 5 V DC to 35 V DC voltage.
4. Check whether the indicator is burned. If so, contact the sales representative of InHand.

3) Failed to configure DTU332/324.

Troubleshooting procedure:

1. Check the serial port cable, whether the PC serial port works normally, and whether the port selected by software is correct.
2. Check whether the output voltage can reach 5 V DC to 35 V DC and whether the polarity is correct.

4) Failed to upgrade the DTU through serial port.

Troubleshooting procedure:

1. Check the serial port cable, whether the PC serial port works normally, and whether the port selected by software is correct.

2. Check whether the output voltage can reach 5 V DC to 35 V DC and whether the polarity is correct.

6 Parameter Settings

6.1 Local Serial Port/Serial Port 2

The DTU serial port parameters should be the same as the serial port parameters of the peer device connected to the serial port.

Table 6-1 Parameter settings for serial port

Parameters	Description	Default
Baud rate	1200, 2400, 4800, 9600, 14400, 19200, 38400, 57600, or 115200, in bps	serial port 1:9600 serial port 1: 115200
Data bit	5, 6, 7, or 8	8
Stop bit	1, 1.5, or 2	1
Parity	None/odd/even	None
Scan interval	Retain the default value.	2
Response timeout	Retain the default value.	5
Max frame size	1024 by default, range: (10-1024)	1024

6.2 Work Mode

According to the below table, set the parameters of the working mode of the DTU, such as the connection mode and activation mode.

Table 6-2 Setting DTU working mode

Parameters	Description	Default
Connection type	Long connection or short connection	Long connection
Phone active	Enable or disable phone active	Enabled
SMS active	Enable or disable SMS active	Enabled
Local data active	Enable or disable local data-flow active	Enabled
Auto active interval	5-1440 minute	0
Auto offline interval	0~60 minutes, the minimum setting time is 1 minute If set to 0, it will automatically adapt to the 1 minute.	0
GPRS/SMS	GPRS or SMS link.	GPRS
Transmit received SMS to serial port	Enable or disable the function. If enabled, received messages are transmitted to the working serial port.	Disabled
Configuration mode	Packet mode or stream mode.	Stream mode

6.3 GPRS Dialing

Table 6-3 Setting GPRS dialing parameters

Parameters	Description	Default
Auto dial	Enable or disable auto dial.	Yes
PPP echo interval	30 to 3600 seconds.	50
Redial interval	0 to 3600 seconds.	60
Max redial times	Once consecutive failed redial times reach to the predefined limit (1-10), the device will automatically hot restart.	3
Dual SIM mode	Enable this function before use SIM No.2. This parameter is invalid for single-card version of DTU	Close
Switchover card when fail to connect center	This parameter is invalid for single-card version of DTU	Close
SIM card	The associate parameters about each SIM	
GPRS dial number	The dial number to access the special cellular network	*99***1#
APN	Access Point Name	cmnet
APN user name	Account for login the APN	gprs
APN password	Password for login the APN	gprs
Authentication mode	Auto/PAP/CHAP	Auto
Network mode	Auto/4G/3G/2G	Auto
Local APN settings	Default setting about SIM, suitable for LTE 4G.	

6.4 Application Center

Table 6-4 Setting application center parameters

Parameters	Description	Default
DTU ID	Custom device identification number. It supports 11 digits number.	0001
Application center	The IP address, port number, and domain name of the center. If the IP and domain name are configured, configure one only.	0.0.0.0/ empty/0
Application center link mode	TCP, UDP, DCTCP, DCUDP, or Modbus bridge The custom heartbeat frame for link maintenance is	TCP

	recommnad when using UDP.	
Max retransmit times	0 (TCP automatically retransmits data times)	5
Forced DC heartbeat	This function will take effect only for DC protocol. “OFF” means that heartbeat will sleep when transmitting data; “ON” means that heartbeat always work even transmitting data;	OFF
Application center heartbeat (min)	The value ranges from 1 to 60, The application center and extend center will share this parameter.	1
Application center heartbeat (s)		0
DNS IP1	The IP address of a dedicated DNS server.	8.8.8.8
DNS IP2		
SNTP service	Enable or disable the SNTP service. The default time 1970-1-1.	Disabled
SNTP server IP	IP address or domain name for SNTP server.	time.nist.gov
Exchange local serial ports	“OFF” means that serial port No.1 is working port, port No.2 is for debug; “ON” means that exchange the role of port 1 and port 2.	OFF
Local TCP server port	Set the listening port for the TCP server. If the value is 0, this feature (TCP server) is disabled.	8888

6.5 Multi-application Center

When using multi-application center, enter the IP addresses, domain name and port numbers. The connection types and heartbeat interval for extend application center will share same parameters with application center.



For unused extend application center, the IP address should be default,0.0.0.0, its domain name is empty.

In order to ensure the efficiency of the equipment, we recommend that no more than 3 centers are connected at the same time.

6.6 Multi-center mechanism

Table 6-6 Setting multi-connection policy parameters

Parameters	Description	Default
Min reconnect interval	Set the minimum interval at which TCP/UDP connection is set up again.	15
Max reconnect interval	Set the maximum interval at which TCP/UDP connection is set up again.	60
Poll/parallel	Parallel: sending data to each center simultaneously; Poll: the priority of execute, application center > application center 2 > application center 3 > application center 4 > application center 5	Poll

6.7 Other Settings

Table 6-7 Setting application extension parameters

Parameters	Description	Default
Max log-in times	Max login times	5
Allow telnet	Enable or disable telnet function	No
Debug mode	Yes or no. If yes is selected, you can view the DTU running logs by using the serial port tool. This setting take effect immediately, the restart is unnecessary.	No
Debug level	detailed log, Chinese brief log, and English brief log.	Detailed log
Low power consumption	Low power consumption, balanced, and high performance. Only some models support the low power mode.	Low power consumption



Because DTU will generate real-time logs in debug mode, turn off this feature, the device will run better.

6.8 InHand Device Manager (DM) platform

Table 6-5 Setting platform parameters

Parameters	Description	Default
SN	Set a 15-bit character string for the network management platform to identify the device. It is defined when manufacture, cannot be modified.	Empty
DM mode	Only SMS, SMS + IP, or disabled.	Only SMS
White List	The trusted list for accessing DTU, the DTU will interact with white list phone number by SMS. If the list is empty, it will receive the SMS of anyone.	Empty
DM ID	Enter the device ID used by the platform to identify the device.	0
DM address	IP address, domain name and port number for DM	0.0.0.0/g.inhandnetworks.com/ 20003
Heart beat interval	Set the heartbeat interval between the DTU and the platform. The value ranges from 30 to 600 seconds.	120
Update interval	Set the update interval about DTU state information between the DTU and the platform. The value ranges from 1 to 65535 seconds.	3600

6.9 Administrator Account

Table 6-6 Setting administrator login parameters

Parameters	Description	Default
Administrator	Set the administrator account name.	adm
Administrator password	Set the password for the administrator account.	123456
Common user	Set the name of the common user.	adm
Common user password	Set the password for the common user.	123456

6.10 ICMP

Table 6-7 Setting ICMP parameters

Parameters	Description	Default
RRC link Maintenance	Maintain the link between the communication module and the base station	Close
Detect interval when network broken	Range 10~120 seconds, only for dual-SIM DTU. If there is no communication data flow at this time interval, ICMP detection will start.	10
ICMP host	The destination IP address for ICMP If the IP is empty, the application center IP will be detected by ICMP.	0.0.0.0
Max lost packets	If the times of consecutive ICMP failure reaches this limit, DTU will redial.	3
ICMP detect interval	1 to 3600 seconds	55
Forced ICMP detect	“OFF” means that ICMP will sleep when transmitting data; “ON” means that ICMP always work even transmitting data.	OFF

6.11 User-Defined Packets

Packet types: ASCII, HEX, and DC.

ASCII type means that the packet uses ASCII characters.

HEX type means that the packet uses HEX characters.

DC type means that packet content will adopt the same format with DC message.

Table 6-8 Setting user-defined packet parameters

Parameters	Description	Default
Log-in	The data content and format of submitted packet form DTU to application center when login	Empty
Log-in ack	The data content and format of responded packet form application center to DTU when login	Empty
Heartbeat	The data content and format of heartbeat packet form DTU to application center after connected	Empty
Heartbeat ack	The data content and format of heartbeat packet form application center to DTU after connected	Empty
Log-out	The data content and format of submitted packet form DTU to application center when log-out	Empty
Log-out ack	The data content and format of responded packet form application center to DTU when log-out	Empty

 **Caution**

The user-defined frame is valid only when the connection type is TCP or UDP. It is recommended that the login frame and the login ack frame must be used in pair. The heartbeat frame and the exit frame are same condition.
