



HY-PTK-100WP20A

# User Manual



## Summary of folding solar panel structure

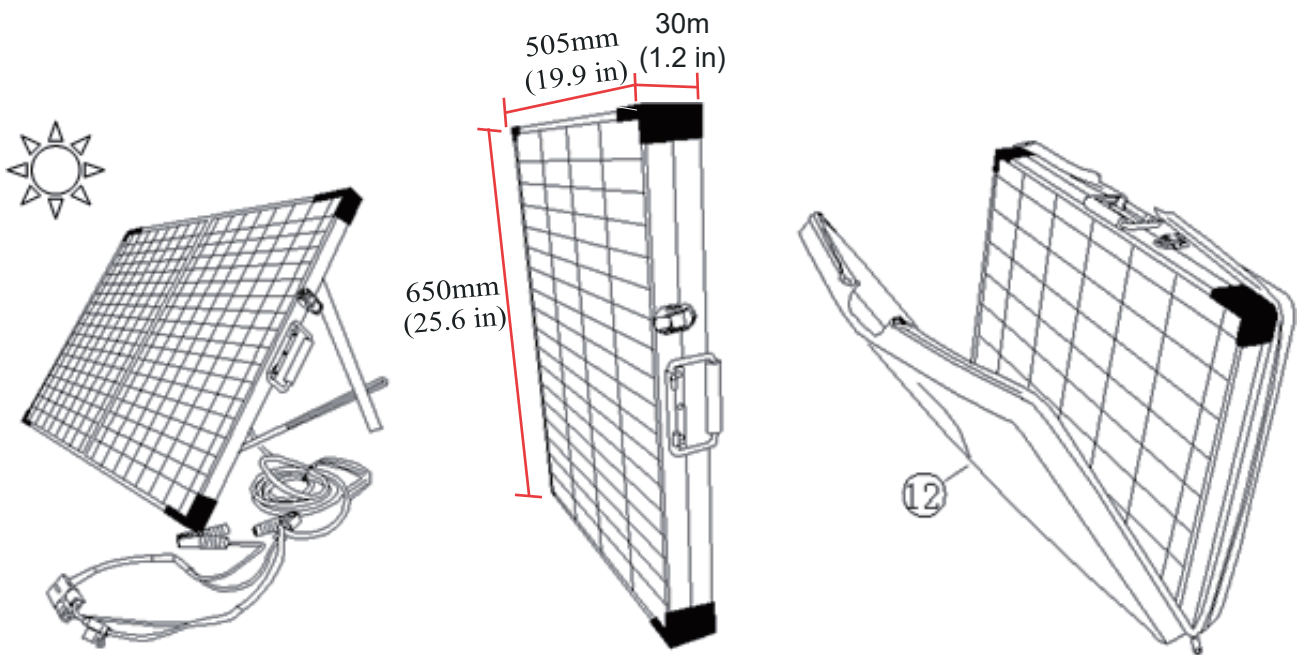

*Power Your Green Life!*

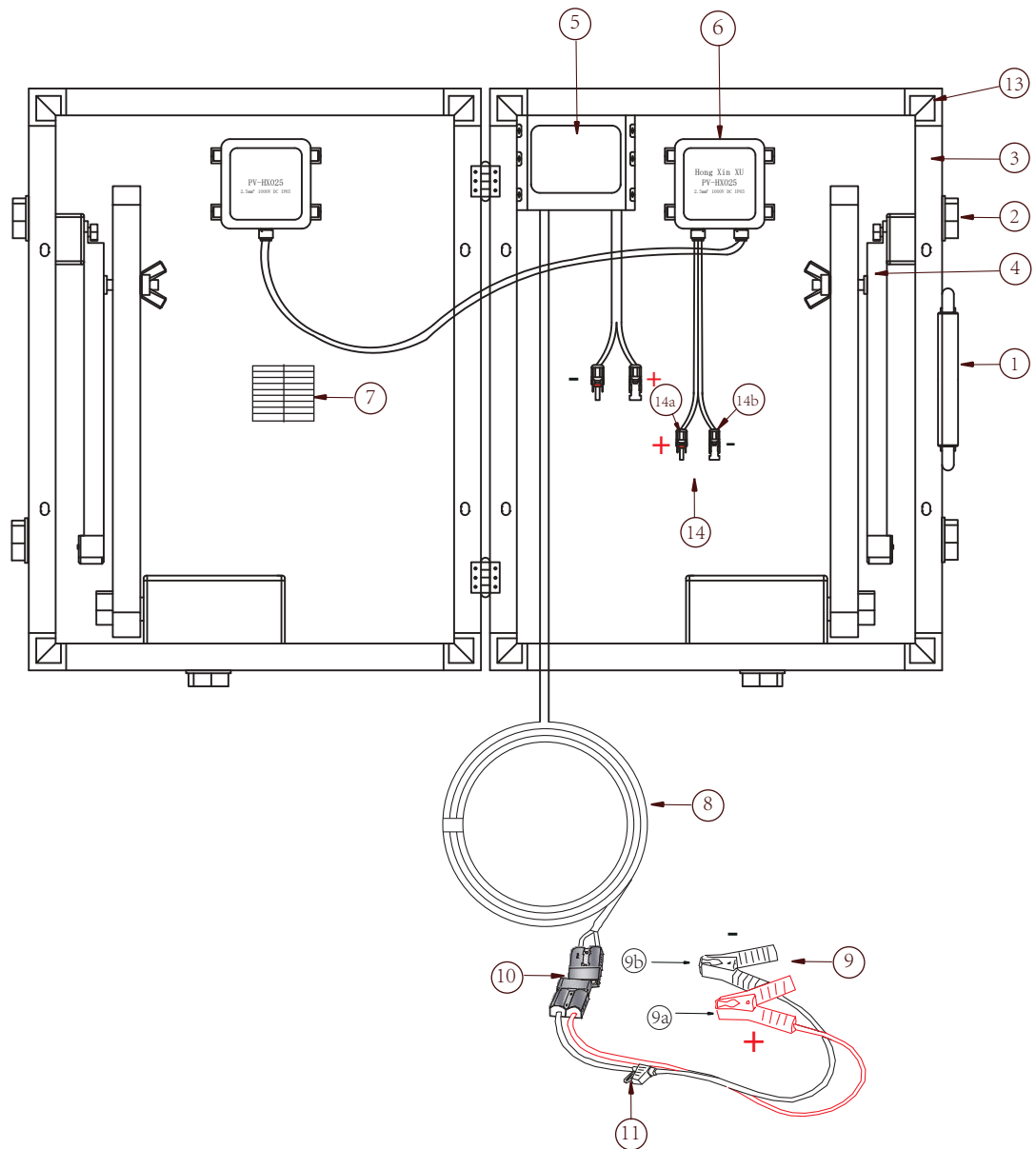

## Accessories:

1. Handle	9a. Red Positive Battery Clip
2. Latches	9b. Black Negative Battery Clip
3. Aluminum frame	10. Anderson Plug
4. Aluminum support legs	11. Fuse
5. Solar charge controller	12. Handy carry bag
6. Junction box	13. Corner protector
7. Label	14. MC4 cables
8. Cable	14a. Red Positive MC4 Cable
9. Battery Clips	14b. Black Negative MC4 Cable

*Power Your Green Life!*

## Introduction

This portable solar panel comes with a pre-installed 20A charge controller. This charge controller protects battery against unsafe electrical conditions and must be used to charge 12V batteries. To charge solar generators with a built-in charge controller, simply use the MC4 cables provided and plug them into the cables that came with your power station to charge. A 12V battery and solar generator can be charged at the same time.

## Features

- Max 100 watts solar panel
- 20A PWM waterproof charge controller
- Portable
- Waterproof IP67 for charge controller and IP65 for whole kit
- MC4 Connectors
- Charge 12V battery by alligator clamps- Sealed, Flooded, GEL, AGM, and other deep cycle batteries
- Charge 12V solar generator by MC4 connectors- battery with inverter, power bank/station with built-in charge controller. ACOPOWER 400wh solar generator recommended. Adapter is needed.
- Can be used on its own or as part of a larger solar system
- Extendable with MC4 Connectors (Max. 200W Solar Panel; needs adapter cables)

## User's guide

After receiving the solar panel kit, please check if all accessories are included in the package and prepare to test your kit:

1. Locate a sunlit area clear from hanging branches or obstacles.
2. Unclip the two latches (2, Table 1) on the side of the unit and fold two panels outward. Extend the two support legs (4, Table 1) to desired length and lock the stands in position. Set solar panel kit in the position facing the sun.

**Tip:** To obtain the maximum output power of solar modules, it is recommended to adjust the solar modules based on solar trajectory.

## How to test the solar panel

Method 1: Use a multimeter

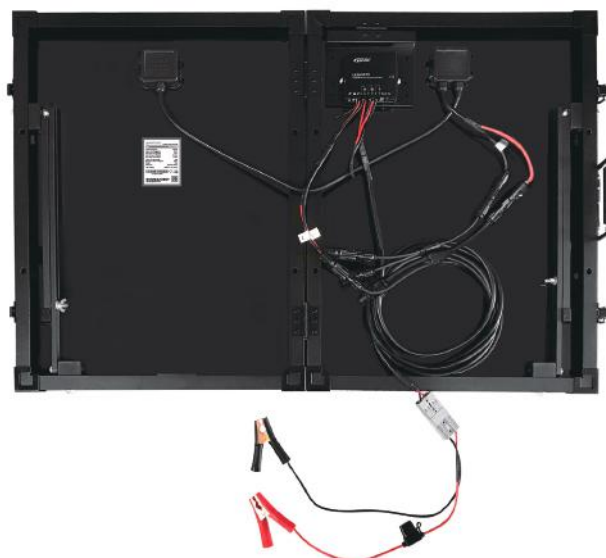

Set your multi-meter to measure DC voltage and put the red probe on the red positive MC4 cable (14a, Table 1) and the black probe on the black MC4 cable (14b, Table 1) and make sure the connections are secure. The open-circuit voltage should be displayed on your multi-meter and it should be around 17.6V-23V. This is your solar panel's voltage without going through the charge controller.

*Power Your Green Life!*

If you're not getting voltage in the range of 17.6V-23V, you should check and make sure the solar panel is in direct sunlight and that the connections between the MC4 cables and the multi-meter is secure.

Method2: Use your solar generator



To test if the solar panel is working with a solar generator with a built-in charge controller, connect the MC4 adapters that came with your solar generator and plug it in to the MC4 cables of the solar panel directly (14a and 14b, Table 1). Turn your solar generator on and it should start charging from the solar panel.

## How to test if the charge controller is working

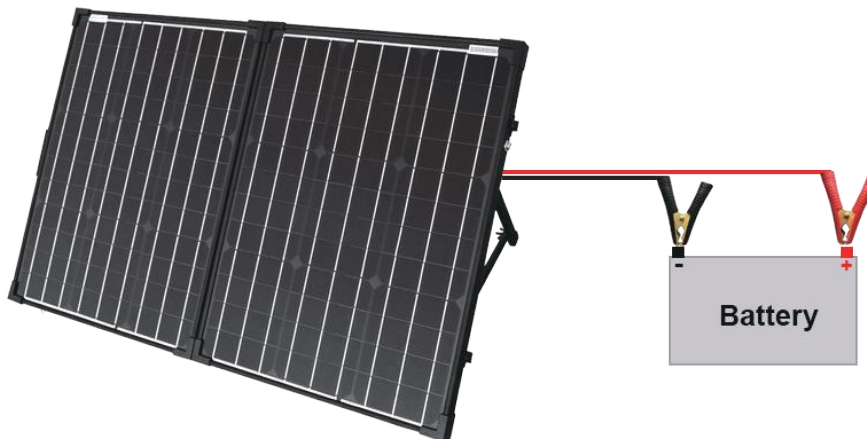

Choose: GEL、 Flooded、 Sealed

**When testing the charge controller, please make sure a battery in working condition is used. The charge controller will not power on with a bad battery. A good thing to do is to test with your 12 V car battery.**

Step 1: Clamp the red positive battery clip (9a, Table1) to the positive terminal of 12V battery, black negative battery clip (9b, Table 1) to the negative terminal and make sure the connection is secure.

Step 2: When all the connections are complete, the Battery status indicator (10, Figure 1) should light up if the battery is connected to the charge controller. If the solar panel is under direct sunlight, the charging status indicator (10, Figure 1) will be on as well. (Detailed information under Specifications section)

**Tip: The charge controller will not respond unless it is connected to a battery!** Always connect the battery first, then load (if applicable).

For lights explanation, please check the Specifications section.

*Power Your Green Life!*

## What are you going to use it for

### 1. Charge solar generators

#### 1.1. Charge 12V Solar Generator with built-in Charge Controller



Step 1: understand your solar generator and prepare the MC4 adapter for your solar generator



Different MC4 Adapters

Step 2: Use your MC4 Adapter to charge your solar generator

### 2. Charge your 12 Volt battery

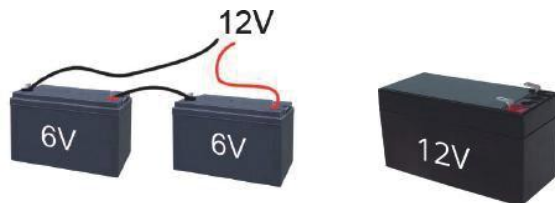

Battery

Lead-acid Battery

The solar panel kit is designed to charge a large range of batteries including Sealed, Flooded, GEL, AGM, lead-acid battery and other deep cycle battery. The batteries are used as car battery, RV battery, boat battery and emergency back-up battery.

Step 1: understand your battery: battery type, capacity and voltage

Step 2: Connect the alligator clamps to your battery, Red to positive (+) and black to Negative (-)

Step 3: If your camper/RV battery is pre-wired with one connector, please contact ACOPower to get more information or purchase the adapter

### 3. Connect in parallel with another solar panel to charge a 12V battery faster

When you combine two solar panels in parallel, the current from the two solar panels are added together and this will enable the battery to charge faster. For more information about the expansion and adapters, please contact us.

**Warning: Make sure the combined current is lower than the rated current of the charge controller which is 20 amps for this model.**

*Power Your Green Life!*

## Specifications

### 100w solar panel

Type	Module Size	N.W	Specification				
			Max-Power	Max-Power Voltage	Max-power Current	Open-Circuit Voltage	Short-circuit Current
Module	mm	Kg	W	V	A	V	A
2*50w	650*505*30 (25.6*19.9*1.2 in)	15 (33.1 lb)	2*50	17.8	2*1.81	22.3	2*3.03

## Charge Controller

The 20A waterproof solar charge controller adopts the most advanced digital technique and operates fully automatically. It is ideal for extreme environments with corrosion, dust, water etc and has various unique functions:

- Electronic protection: Over charging, over discharging, overload, short circuit and reverse protection of solar module
- High efficient Series PWM charging, increase the battery lifetime and improve the solar system performance
- Widely used, automatically recognize day/night
- Battery LED indicate battery status
- Industrial design, wide application range
- Digital tube menu, only one key solve all setting simply
- Intelligent timer function with 1 ~ 13 hours option
- IP67 protection

### 1. Features and Mounting

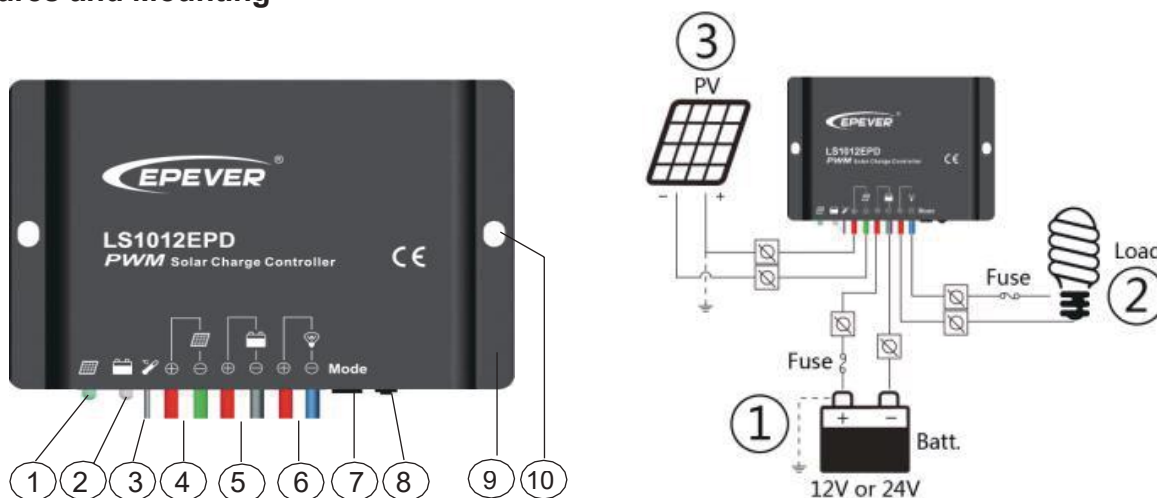

Figure 1 Characteristic

*Power Your Green Life!*

①	Charging Status LED indicator	⑥	Load Terminals
②	Battery Status LED indicator	⑦	Digital tube
③	Temperature Sensor	⑧	Key
④	Solar Module Terminals	⑨	Aluminum housing
⑤	Battery Terminals	⑩	Mounting hole Φ5

## 2. Indicators Description and Operation

### 2.1 Indicator Status Description

Charging Status LED indicator	Green	On Solid	PV connection normal but low voltage(irradiance) from PV, on charging
	Green	OFF	NO PV voltage(night time) or PV connection problem
	Green	Slowly Flashing	PV In Charging
	Green	Fast Flashing	Over voltage
Battery Status LED indicator	Green	On Solid	Normal
	Green	Slowly Flashing	Full
	Orange	On Solid	Under voltage
	Red	On Solid	Over discharged
Radix Point of Digital tube (Load indicator)	Red	On Solid	Load ON
	Red	Slowly Flashing	Over Load
	Red	Fast Flashing	Short Circuit

### 2.2 Operation

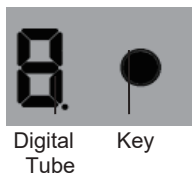

The digital tube display the load work mode, please refer to the correspondence table of Load Work Mode & LED digital tube value. Pressing the key to configure the parameter, please refer to the below configuration method:

- 1) After Powering on, disconnect the PV or connect the PV(Voltage<5V) , the light of the digital tube point go on; Connect the PV(Voltage>6V) ,the light of the digital tube point go off.
- 2) The key can be used to operate switching on/off the load (Manual control) or clearing the faults
- 3) Keeping pressing the key button over 5S, It will go to the parameter in browsing mode which can cycle through the parameter item by clicking the button ,after the light of the digital tube point going on.
- 4) After the digital tube displaying the value what you want to configure, releasing the key and waiting 15S, Digital Tube stop flashing, then the configuration is successful.

*Power Your Green Life!*



## Load mode

- Manual Control: Control the load via the button.
- Light ON/OFF
- Light ON + Timer

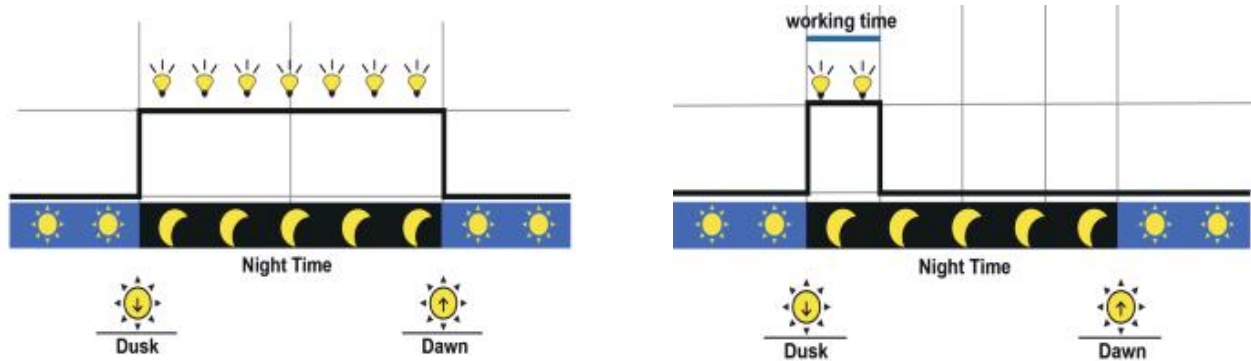

**Note:** In the mode of Light ON/OFF and Light ON/Timer, the Load is turned on after 10Min. delay.

- Test Mode (Default): Test Mode is as same as Light Control Mode but no delay.

### The correspondence table of Load Work Mode & LED digital tube value

Value	Working mode	Value	Working mode
0	Light ON/OFF	0.	Light ON + 8 hours
1	Light ON + 1 hours	1.	Light ON + 9 hours
2	Light ON + 2hours	2.	Light ON + 10 hours
3	Light ON + 3hours	3.	Light ON + 11 hours
4	Light ON + 4 hours	4.	Light ON + 12 hours
5	Light ON + 5 hours	5.	Light ON + 13 hours
6	Light ON + 6 hours	6.	Manual Control
7	Light ON + 7 hours	7.	Test Mode

*Power Your Green Life!*

## 3. Troubleshooting

Faults	Possible reasons	Troubleshooting
Charging LED indicator off during daytime when sunshine falls on PV modules properly	PV array disconnection	Check that PV and battery wire connections are correct and tight
Charging Status LED indicator fast flashing	Battery voltage higher than over voltage disconnect voltage	1. Disconnect the solar array and measure the battery voltage whether is too high; 2. Change the controller; 3. Change the battery
Battery LED indicators red color and loads not working	Battery over discharged	The controller cut off the output automatically. LED indicator will return to green automatically when fully
The radix point of digital tube fast flashing and load not working	Short circuit	Clear short circuit. It is reactivated after delayed 10 seconds for the first time, If over 1 time, press the key to clear error and the controller will resume to work after 3s or restart the controller
The radix point of digital tube slowly flashing and load not working	Over load	Please reduce the number of electric equipments. When load power reaches 1.25-1.5 times, 1.5-2 times and 2 times more than nominal value, controller will automatically close loads in 60 seconds, 5 seconds and 1 second, respectively. Please press the key to clear error and the controller will resume to work after 3s or restart the controller

*Power Your Green Life!*

**4. Technical Specifications**

Item	LS1012EPD	LS1024EPD	LS2024EPD
Nominal system voltage	12VDC	12/24VDC Auto	12/24VDC Auto
Max. PV input voltage	30V	50V	50V
Rated current	10A	10A	20A
Equalize Voltage	14.8V(12V);29.6V(24V)		
Boost Voltage	14.4V(12V);28.8V(24V)		
Float Voltage	13.7V(12V);27.4V(24V)		
Low Voltage Reconnect Voltage	12.6V(12V);25.2V(24V)		
Low Voltage Disconnect Voltage	11.2V(12V);22.4V(24V)		
Self-consumption	12V: ≤4.58mA; 24V: ≤6.01mA		
Temperature compensation coefficient	-5mV/°C/2V (25°C)		
Working temperature	-35°C~+55°C		
Enclosure	IP67		
Overall dimension	108.5mm×75mm×25.6mm		
Mounting dimension	100.5mm		
Mounting hole size	Φ5		
Power cable	PV/BAT/LOAD:4.0mm <sup>2</sup>		PV/BAT/LOAD:6.0mm <sup>2</sup>
Net weight	408g	410g	435g

*Power Your Green Life!*

## FREQUENTLY ASKED QUESTIONS(FAQ)

ACOPOWER is always open to customers with technical support, if you have any issues, please feel free to contact ACOPOWER by email at [support@acopower.com](mailto:support@acopower.com)  
Here we collected some frequently asked questions for reference:

Q: What type of batteries can be used with the kit?

A: 1. sealed lead-acid battery (Sealed) 2. colloidal lead-acid battery (Gel) 3. the opening lead-acid batteries (Flooded)

Q: How to clean the solar panel surface?

A: When dust and dirt cover the surface of solar module, it can be cleaned with a soft brush, then use a damp cloth to wipe the surface to remove the remaining dust and dirt. Anything that covers the solar cells should be removed as soon as possible so as not to affect performance.

Q: Are the foldable solar modules are waterproof?

A: Yes, it is IP65 Waterproof for the kit and IP67 for charge controller.

Q: How can I get my battery's information?

A: To get your battery's information, please contact your battery's manufacturer or check your battery label.

Q: Can I use an extension cables in the system?

A: Yes, an extension cable can be insert between Anderson Connectors.

Q: How do I get the MC4 Adapter for my solar generator?

A: Please contact your solar generator's seller or manufacturer to get a MC4 adapter. The MC4 is a solar industrial universal connector. If your solar generator's supplier does not provide it, please contact ACOPOWER to get it customized.

Q: It worked for my car battery and it does not charge my solar generator. What is the problem?

A: Please check your solar generator's connection and voltage. Some generators in the market are designed to be unique like 24V battery. Most solar generators in the market are 12V. Please contact your solar generator's supplier for the voltage confirmation.

Q: My battery is two 6V batteries in series, can I use this kit?

A: Yes, two in series is considered a 12 Volts battery.

Q: My battery is AGM, which battery setting shall I use?

A: No settings needed

Q: My battery is lithium battery, which battery setting shall I use?

A: Sorry, the charge controller does not work for Lithium Battery.

Q: Will the system discharge my battery after sunset?

A: No, the controller avoids discharging from battery.

*Power Your Green Life!*

Q: Can I use my own controller, or can I use MPPT charge controller?

A: Yes, the charge controller is not permanently installed in the back, it is mounted on one panel.

Q: I connect the kit with my battery with red clamp to Positive and black clamp to Negative.

Why the lights of charge controller are not on?

A: we suggest charging your car battery for the kit's test. And then test your solar panel's open circuit voltage and battery's voltage. If the solar panel open circuit voltage is good and the battery's voltage is lower than rechargeable voltage, the battery should be recharged some other way or replaced before charging with the solar panel.

Q: Can I use the solar panel to jumpstart a drained battery?

A: No, the drain car battery has lower voltage than what the kit could recharge. Therefore, please jump start the battery and make sure the voltage of battery is high enough, then charge it by the solar panel.

Q: Can I use the solar panel to avoid my battery drain? A: Yes.

Q: My RV has a Zamp solar plug or other types of plugs, how do I use this solar panel kit?

A: You will need to refer to the RV user manual and find out what kind of adapter you may need. Most adapters are sold on Amazon. Please contact [support@acopower.com](mailto:support@acopower.com) if you can't find what you need.

Q: What if I want to permanently install the battery's terminal?

A: Please contact ACOPower for accessories from Anderson Connector to Ring Terminal on your battery.

Q: The solar panel kit has the correct voltage reading but it won't charge my generator.

A: Please check the voltage rating of your generator, it might be rated at 24V and this solar panel kit is only for charging 12V batteries. Another possibility is that the generator is already fully charged.

## Safety Tips

- **Before using the product, read all safety precautions.**
- **If the product is abnormal or damaged, do not use.**
- **Do not allow water to enter the controller**
- **Prevent sharp objects from impacting the surface of solar modules**
- **Ensure proper battery clip connection to prevent short circuits.**
- **No user license serviceable parts inside.**
- **Do not disassemble or attempt to repair it.**

*Power Your Green Life!*

## Warranty

### Limited Product Warranty-One Years Repair, Replacement and refund Remedy, but fuse excluded

The solar panel itself comes with an 18-months workmanship warranty and a 25-year 85% output warranty.

**Within 30 days of purchase:** Items can be returned for a full refund or replacement, we will cover return shipping due to quality issues, buyer pays return shipping and replacement shipping due to non-quality issues.

**Within 30 days to 6 months:** Items can be replaced new or refurbished due to quality issues, we will cover return shipping. Items can be replaced with a restocking fee due to non-quality issues, buyer pays for all shipping.

**Within 6 months to 18 months:** Items can be replaced refurbished due to quality issues, buyer pays for all shipping.

#### Accessories:

**Within 30 days of purchase:** Items can be returned for a full refund or replacement, we will cover return shipping due to quality issues, buyer pays return shipping and replacement shipping due to non-quality issues.

**Within 30 days to 6 months:** Items can be replaced new or refurbished due to quality issues, we will cover return shipping. Items can be replaced with a restocking fee due to non-quality issues, buyer pays for all shipping.

**Within 6 months to 18 months:** Items can be replaced refurbished due to quality issues, buyer pays for all shipping.

#### Charge Controller:

The controller itself comes with a 1-year warranty.

**Within 30 days of purchase:** Items can be returned for a full refund or replacement, we will cover return shipping due to quality issues, buyer pays return shipping and replacement shipping due to non-quality issues.

**Within 30 days to 6 months:** Items can be replaced new or refurbished due to quality issues, we will cover return shipping. Items can be replaced with a restocking fee due to non-quality issues, buyer pays for all shipping.

**Within 6 months to 1 year:** Items can be replaced refurbished due to quality issues, buyer pays for all shipping.

Seller shall not be responsible or liable in any way to the customer or any third-party arising from any non-performance or delay in performance of any terms and conditions of sale, including this "Limited Warranty for PV Modules", due to acts of God, war, riots, strikes, warlike conditions, plague or other epidemics, fire, flood, or any other similar cause or circumstance beyond reasonable control. such cases, this Limited Warranty shall be suspended without liability for the period of delay reasonably attributable to such causes.

Register your warranty with ACOPWER, please visit: <https://www.acopower.com> select "Warranty Registration".

Thank you for your business and support!  
ACOPower Team  
technical support: [support@acopower.com](mailto:support@acopower.com)  
[www.acopower.com](http://www.acopower.com)



Warranty Registration Web

*Power Your Green Life!*