

1 Packing list

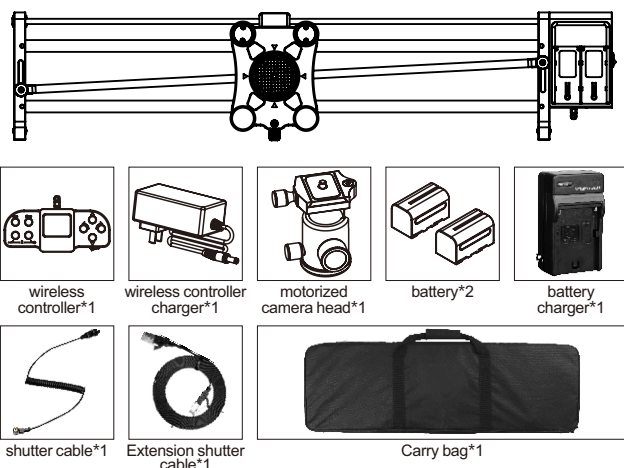

2 Mounting the slider and camera

1. Please charge the wireless controller and battery before using this product.

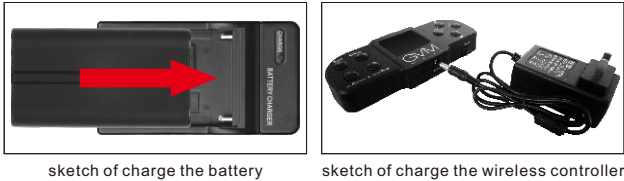

2. Please install and use this product as shown in the picture.

1) Mounting the motorized camera head on the slider. (As shown below)

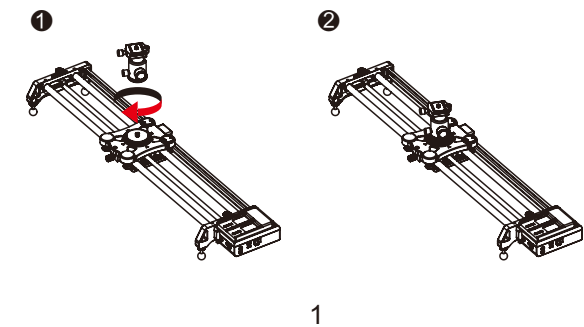

2) Mounting the camera on the slider. (As shown below)

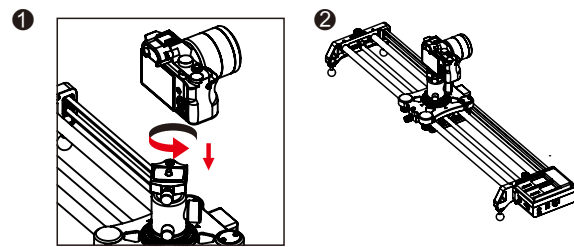

3) Connect the extension shutter cable. (As shown below)

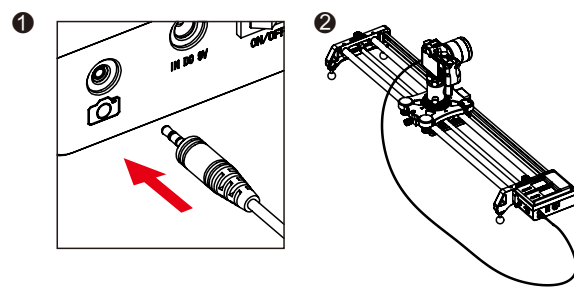

4) Install the battery on the slider and check the signal cable or shutter cable connecting correctly or not. (As shown below)

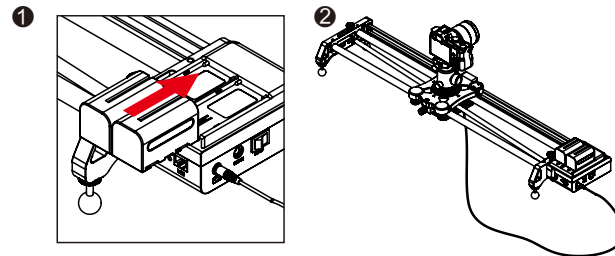

3 Slider motion

1. Turn on the slider and wireless controller. (The slider's LED indicator light open and blinking, the controller's screen open as shown below)

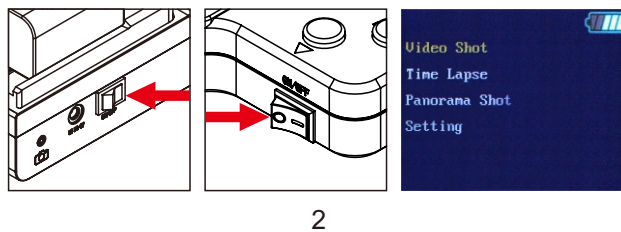

2. **Bluetooth wireless connection:** press "Setting"- "Bluetooth Setting"- "Searching Device"-choose the device code which start with letter D-press "OK" button to confirm the device(The upper right of the screen will show ->-> if the connecting is successful)

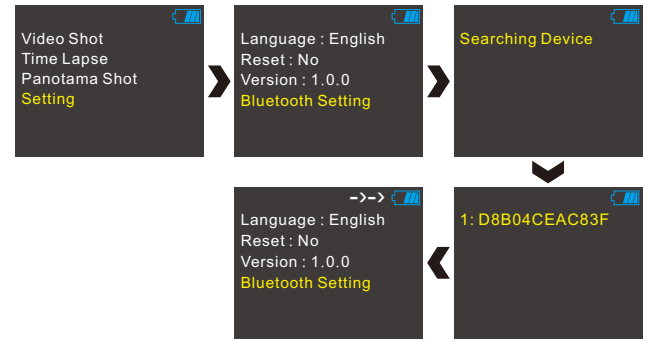

3. **Manual operation mode:** "Video Shot"- "Manual Mode" (Press the button of the controller and the orbit will act accordingly)-choose the "speed" menu can adjust the current speed.

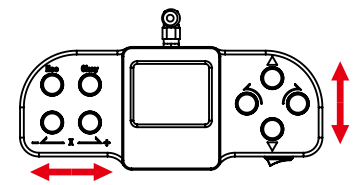
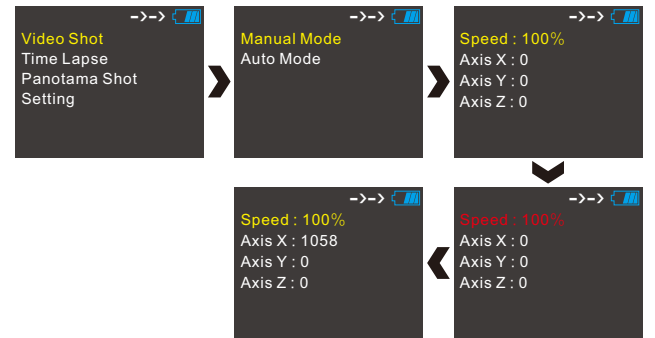

4. **Auto operation mode:**

① **Setting the append point:**
A: "Video Shot"- "Auto Mode"- "Set key"- "Append Point A" (Move the camera to the start point you need)- "Save: Yes" (As shown below)

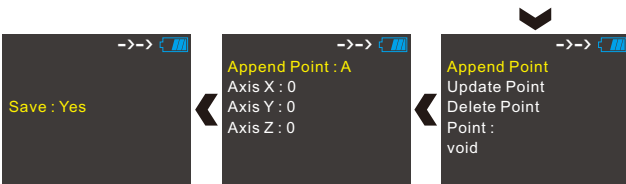
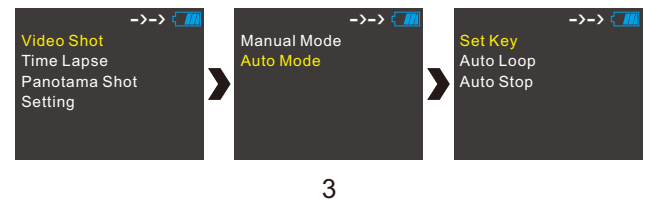

B: "Video Shot"- "Auto Mode"- "Set key"- "Append Point B" (Move the camera to the end point you need)- "Save: Yes" (As shown below)

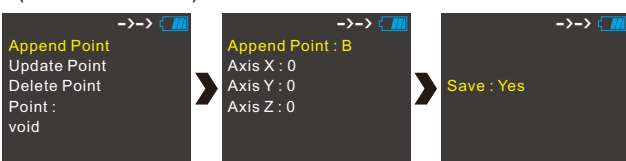

The slider have three Photography Methods. You can choose-follow these methods: horizontal shooting / follow focus shooting and 120° Panorama shooting.

Horizontal shooting:

The camera Angle remains constant. Loose the adjusting rod's brake, Center the adjusting rod on the both feet, lock the brake.

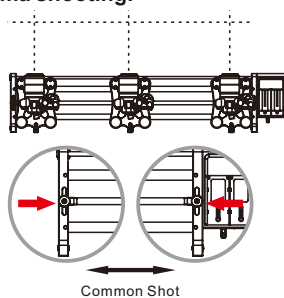

Follow focus shooting:

The camera Angle follow focus on the target. Loose the adjusting rod's brake, adjust the adjusting rod to the upper left corner and the lower right corner, lock the brake.

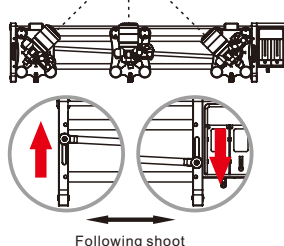

120° Panorama shooting:

The camera Angle can be 120° shooting. Loose the adjusting rod's brake, adjust the adjusting rod to the upper right corner and the lower left corner, lock the brake.

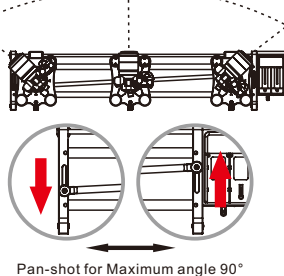

② Auto Loop mode:

"Video Shot"- "Auto Mode"- "Auto Loop"-adjust the "Speed"- setting the start point-setting the end point-setting the "Loop Count"- "Execution" (As shown below)

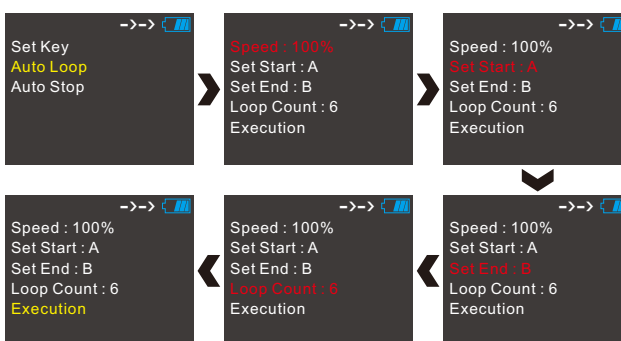

5. **Time Lapse:** "Time Lapse Setting" - setting the "Times", "Photos", "Stop Time", "Delay Time", "Set start" and "set End" - "Execution" (As shown below)

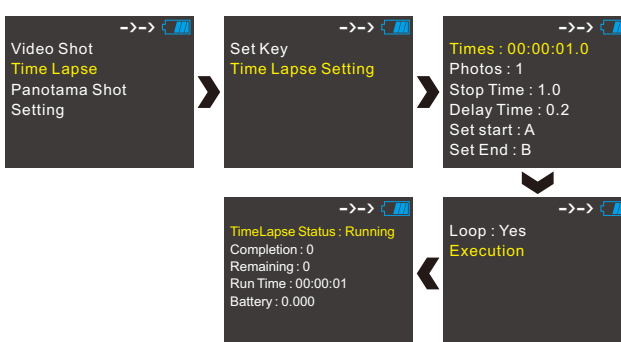

6. **panorama shot:** Setting the "Diagonal A" and "Diagonal B" - Setting the "Axis X photos" (As shown below), then press "Execution"

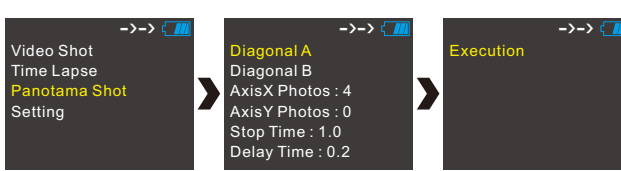

GVM
Great Video Maker

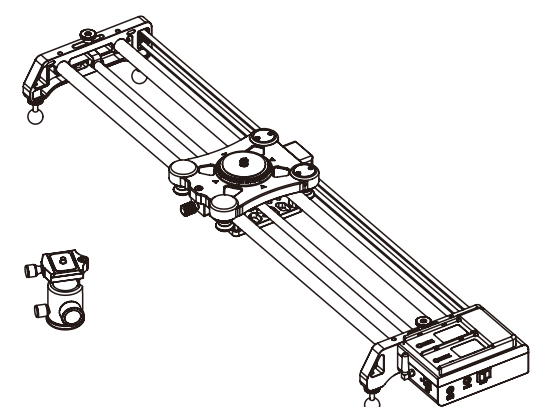

GVM - 1.5D
MOTORIZED SLIDER